



NINZ S.p.A. - corso Trento, 2/A
I-38061 ALA (TN) / ITALY www.ninz.it
Tel. + 39 0 464 678300
Fax. +39 0 464 679025 info@ninz.it

EXUS LP BSP
PANIC EXIT DEVICE
for emergency exits

A049-GB

5001146/2 - 01/15



Denomination	EXUS LP PANIC EXIT DEVICE
Name and address of the producer	NINZ S.p.A. - corso Trento 2/A I-38061 ALA (TN) - ITALY
Year application trademark	2007
Standard	EN 1125:2008
Certification authority nr.	0425
CE certification number	0425 CPD 1228
Classification	3 7 7 B 1 3 2 1 A A

Commercial codes
EXUS LP BSP
EXUS LP DC BSP

item 4201101.002
item 4201101.011

Classification nr.

- 1st Character - grade 3 - Category of use: high frequency
- 2nd Character - grade 7 - Durability: 200.000 cycles
- 3rd Character - grade 7 - Mass of the door: over 200kg
- 4th Character - grade B - Suitable for use on fire/smoke rated doors
- 5th Character - grade 1 - Safety: suitable for emergency exits
- 6th Character - grade 3 - Highly resistant to corrosion 96h
- 7th Character - grade 2 - Safety of goods: 1000N
- 8th Character - grade 1 - Protrusion of the exit bar: up to 150mm
- 9th Character - grade A - Activation type: push bar
- 10th Character - grade A - Suitable for 1 or 2 leaved door

Suitable for doors with one leaf or for the active (first opening) leaf of two-leaved doors up to 1350x2880mm/leaf in size, a mass of up to 300kg/leaf, mounted on hinges or pivots, fire resistant up to EI₂120 - REI120 and smoke proof. Protrusion of the exit bar: 125mm.

SYMBOLS EMPLOYED



CAUTION
Indicates a danger that threatens people and/or material goods. Failure to observe the warnings indicated by this symbol may have serious consequences, such as personal injury and property damage.



ATTENTION
Indicates a danger that threatens material goods. Failure to observe the warnings indicated by this symbol may result in damage to material goods.



NOTICE
Warnings related to important technical aspects.

PRODUCT DESCRIPTION

Panic bar for one-leaved doors or for the active leaf of two-leaved doors located at emergency exits and activated by push-bars. Composed of galvanized steel controls, black plastic casing and lever, horizontal aluminium bar, fixed external doorknob and nickel-plated brass cylinder with three keys.

This product does not contain or release any hazardous materials, as per UNI EN standard nr. 1125 appendix ZA.

OPERATION MODE

From the pull side (fixed doorknob side), the door can only be opened by key, which retracts the latch bolt, whereas opening is possible from the push side at any time by pushing on the horizontal bar of the EXUS LP BSP panic bar.

WARNINGS

The EXUS panic bar activated by means of a horizontal bar is intended for use onto doors installed in escape routes where panic situations could develop.

The safety features of this product are of fundamental importance to ensure its conformity with EN 1125. It is strictly forbidden to introduce any type of modifications apart from those described in these installation instructions.

RECOMMENDATIONS

In order to ensure that the panic bar could provide a high level of safety toward people and appropriate safety level toward goods, it should only be mounted onto doors and doorframes that are in good conditions. The door itself, therefore, should be checked to ensure that it was installed properly and that nothing obstructs its normal movement.

If door rebate sealing have been mounted on the door, make sure they do not inhibit proper functioning of the panic bar.



In case of two-leaved door where both leaves are equipped with panic bar, it is mandatory to check that each leaf opens when its respective panic bar is activated, and that leaves open freely when the bars are activated simultaneously.

The fastening instructions in the present document should be followed scrupulously during installation. Once installation is complete, the installer should give this document to the owner of the activity.

The horizontal bar should be installed in a way that maximizes its useable length.

For securing the door in the closed position, do not employ any other latching devices than those specified in the present document. This does not preclude the installation of automatic closing devices.

Different external access devices than those found on the list of certified components on pages 4/4 are considered unacceptable.

The EXUS panic bar is also designed for installation on hollow metal doors with an internal cell structure.

If a door closer is needed to return the door to the closed position, care should be taken not to make the opening step more difficult for children, the elderly and the disabled.

A pictogram (arrow) should be positioned immediately above the horizontal bar on the internal side of the door.



All of the included components described herein must be positioned and mounted in conformity with the present document.

BSP version with fixed stainless steel doorknob

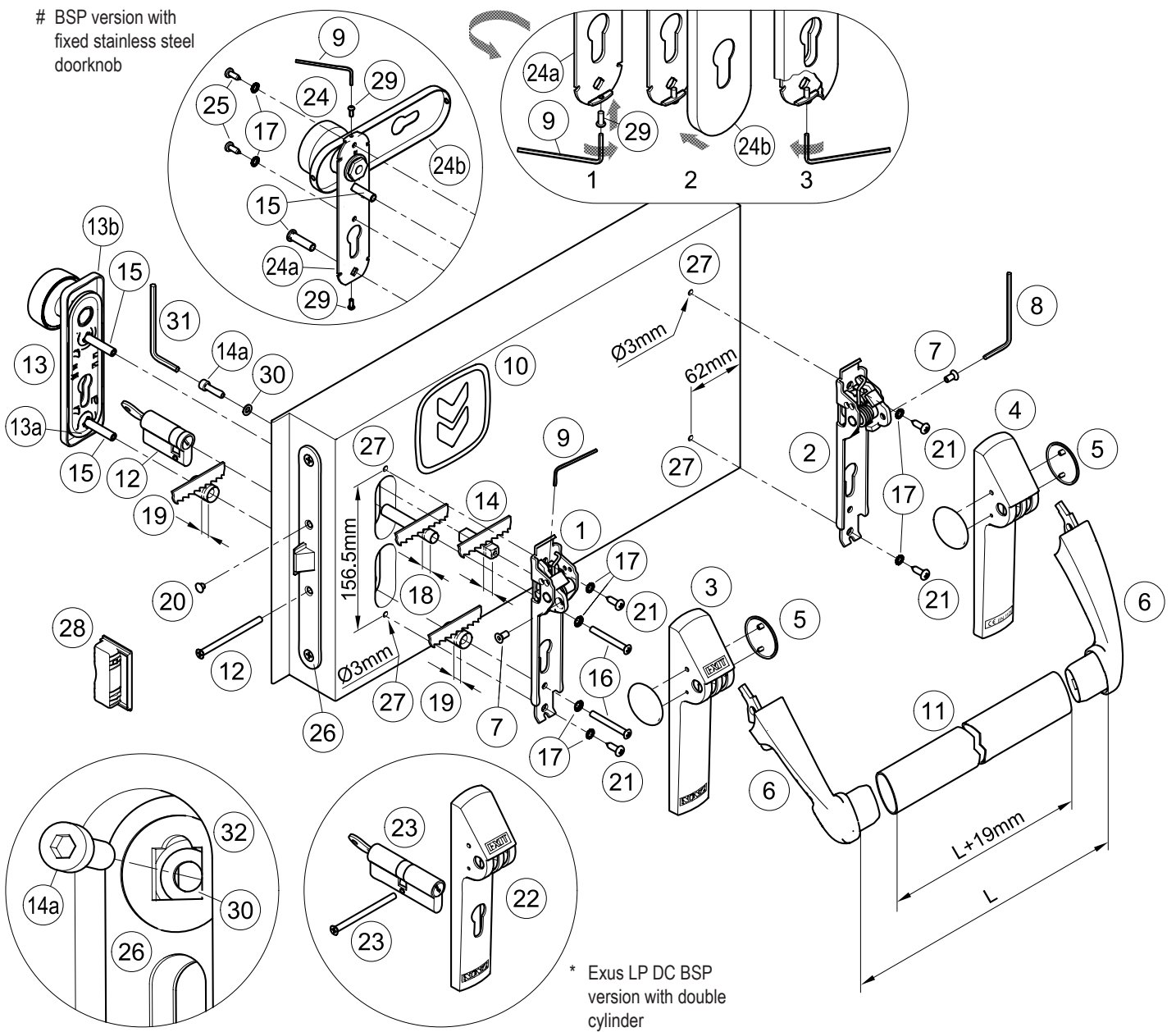

CONTENTS OF THE EXUS LP BSP PANIC BAR PACKAGE

position	pcs.	description	position	pcs.	description
1, 2	01	Twist/Exus mechanism assembly	18	01	Ø10,3x60,6mm spacer
3, 4, 5	01	Twist/Exus LP carter set with plugs	19	02	Ø15,0x23,5mm spacer
6	01	Exus LP set carrier arms	20	01	Black cap hole Ø8,8mm
7	02	M5x10mm hex socket countersunk screw	21	04	Pan head self tapping screw Ø4,8x16mm
8	01	S3 hex key	* 22	01	Exus LP DC carter set
9	01	S2 hex key	* 23	01	Double nickel-plated cylinder with three keys and fastening screw
10	01	Adhesive pictogram (green arrow)	# 24, 24a, 24b	01	Fix doorknob with stainless steel cover plate and galvanized steel installation plate
11	01	Horizontal bar in anodized aluminium	# 25	02	Pan head self tapping screw Ø4,2x13mm
12	01	Standard nickel-plated half cylinder with three keys and fastening screw	# 29	02	M3x8mm pan head screw
13, 13a, 13b	01	Fix doorknob with black plastic cover plate and galvanized steel installation plate	30	01	Washer
14, 14a	01	9x9x40mm threaded square spindle with M5x20mm hex socket screw	31	01	S4 hex key
15	02	M5 threaded insert	-	01	A034 hole-drilling template
16	02	M5 countersunk pan head screw	-	01	Exus LP BSP panic bar installation instructions
17	06	Toothed washer (# 8 pcs. for stainless steel version)			

- The panic lock (26) and the respective strike box (counterstrike) (28) are delivered already mounted on the door!

Please note that article 4 of the MD of 03 November 2004 obliges the installer to write up, sign and provide the owner of the activity with a declaration of proper installation that makes explicit reference to the instructions supplied by the exit device manufacturer.

TOOLS REQUIRED

Medium-sized Phillips-head screwdriver or electric screwdriver, electric drill with Ø2 and Ø3mm drill bit for steel, fine-toothed hack-saw and hack-saw for aluminium.

IMPORTANT

- Installation should be carried out by qualified personnel only and in strict conformity with the instructions supplied.
- For a correct installation all supplied components must be used, including spacers and toothed washers.
-  - No variations are allowed, and only components indicated in the package contents may be used.
- Given its purpose, the Exus LP BSP panic bar should be mounted on the push-side of the door.
- Before proceeding with installation, check the package contents to ensure that no pieces are missing, keeping in mind that only the Exus LP DC BSP panic bar includes a double cylinder.
- Check if the door is equipped with the panic safe lock.
- Check the type of doorknob to apply and follow the specific instructions.
- Any different installation configuration from that illustrated on page 2/4 is not allowed.

INSTALLATION

- Insert the cylinder (12 or 23) and fasten it temporarily with the screw (12 or 23), then remove the key.
- Adjust the plastic spacers (18 and 19) to the thickness of the leaf so that they do not protrude from its surface.
- Adjust the threaded square spindle (14) to the thickness of the leaf so that it protrudes 11±1mm from the door surface; be careful to cut the bevelled side.
-  - Insert the washer (30) over the square hole of the panic safe lock (26), from the pull-side of the door, as showed in drawing (32). Insert the M5x20mm screw (14a) over the washer (30) and screw it at the square spindle (14), using the S4 hex wrench (31). Make sure that washer and square spindle are correctly inserted over the square holes before tighten the screw (14a).
- In case of stainless steel doorknob (24), screw onto installation plate (24a), the screws (29), just enough to insert the cover plate (24b). Insert the threaded inserts (15) in the installation plate of the doorknob, making sure it is well-centred.
- Insert the two spacers (18 and 19) over the threaded inserts (15) and apply the doorknob on the pull-side of the door, being careful to center the inserts over their respective holes.
- Apply the operating mechanism (1) to the lock side (push-side of the door) after inserting the screws (16), toothed washers (17) and spacer (19). Center the square spindle, screws and cylinder (the latter for the Exus LP DC version only), starting the screws by hand before fastening them with the screwdriver.
- Use the template to drill the holes (27) with the Ø3mm drill bit, checking the level. If holes are already present, drill them again for the internal reinforcement.
- Fasten the mechanism (1) even more securely with the self-tapping screws Ø4,8x16mm (21) and their toothed washers (17).
- Fix the square spindle (14) at the operating mechanism (1), using the S2 hex wrench (9).
- Fasten the mechanism (2) of the panic bar at hinged side, using the self-tapping screws Ø4,8x16mm (21) and their toothed washers (17).
- Put the plastic carter with "EXIT" wording (3 or 22) on the operating mechanism (1) and the other one (4) on the hinged side mechanism (2), snapping them on manually.
- Apply the carrier arms (6) and fasten them with the dedicated screws (7), tightening them securely with the included S3 wrench (8).
- Make a precise "L" measurement, cut the aluminium bar (11) adding 19mm and remove the burrs from the cut edge. Remove one carrier arm, attach the bar and re-fasten the entire assembly.
- Apply the plugs (5).
- Finish fastening the cylinder (11 or 23), insert the little cap hole (20) in the open hole of the panic safe lock (26).

-  - Push the Exus LP BSP panic bar at any point along the horizontal bar, checking to ensure that the latch bolt opens easily and fully. Use the same method to check the external side, using the key to retract the latch bolt. Test the door in both open and closed positions, and if necessary file down the plastic strike box (28) of one-leaved doors, or the panic safe lock for inactive leaf of two-leaved doors.



- In case of stainless steel doorknob (24), it is also necessary to fasten the installation plate (24a) using the self-tapping screws Ø4,2x13mm (25) and their toothed washers (17) after drilling holes in the metal panel with the Ø2mm drill bit. Insert the cover plate (24b) onto installation plate (drw. 2). Using the S2 hex key (9), unscrew the screws (29) until the cover become fixed, avoiding any deformation (drw. 3).
- Apply the pictogram (10) with the green arrow on the internal surface of the door, just above the horizontal bar.
-  - Lastly, use a dynamometer to measure the force required on the horizontal bar to release the lock. Record this force measurement in the present document.



USE

- Ensure that the door always opens easily.
- Avoid unnecessary strains on or handling onto doorknob and exit bar.
- Protect the panic bar from external atmospheric agents.
- Ensure that nothing hinders the free movement of the horizontal bar.
- Do not paint the lock.
- Use the bar properly, do not pull it in the wrong direction.
- Do not leave the key in the lock.
-  - Make sure that any damaged or malfunctioning parts are replaced immediately.

MAINTENANCE

To ensure that door usage conforms with regulations, the following maintenance checks should be carried out at least once a month:

- Confirm that all of the installed components correspond with those listed in the present instructions and that no other latching devices than those originally installed have been added to the door.
- Inspect and activate the panic bar to verify that all of its components are in satisfactory operational condition.
- Use a dynamometer to confirm that the release force shows no significant differences from the forces recorded at the time of installation.
-  - Check whether all screws are fully tightened, tightening any that may have loosened.
- Check whether panic bar and key can be moved with minimal effort, and that the latch bolt of the lock retreats from the strike box without offering resistance. If the door has become difficult to open due to friction, the resistance can be reduced by filing the strike box down to the appropriate height.
- Activate the Exus LP BSP panic bar at both ends of the horizontal bar, checking to ensure full retraction of the latch bolt in both cases.
- Ensure that the latch bolt exits completely when the horizontal bar is released.
- Check the horizontal bar and replace it if any damage or deformities are detected.
-  - Check whether the inserts and strike boxes are blocked in any way and eliminate any obstructions.
- This product requires no special maintenance. Grease spray should be used to lubricate the internal workings of the lock and panic bar on a regular basis
 - the latter has a hole on its carter for this purpose, located below the carrier arms.
- For normal cleaning use mild detergents.

-  - Any adjustments that become necessary must be carried out by qualified personnel using original NINZ replacement parts.
-  - The owner of the activity is responsible for keeping the declaration of correct installation on file, conducting proper panic bar maintenance in accordance with all of the manufacturer's maintenance guidelines, keeping maintenance and check-up records and preserving the present document.

