



NINZ S.p.A. - corso Trento, 2/A
I-38061 ALA (TN) / ITALY www.ninz.it
Tel. + 39 0 464 678300
Fax. +39 0 464 679025 info@ninz.it

SLASH INOX BM
PANIC EXIT DEVICE
for emergency exits

A080-GB

5001177/2 - 12/14



Denomination	SLASH INOX PANIC EXIT DEVICE
Name and address of the producer	NINZ S.p.A. - corso Trento 2/A I-38061 ALA (TN) - ITALY
Year application trademark	2007
Standard	EN 1125:2008
Certification authority nr.	0425
CE certification number	1308-CPD-2007
Classification	3 7 7 B 1 3 2 2 B A

Commercial codes
 SLASH INOX BM Proget (without holes cover plate) item 4201101.078
 SLASH INOX BM item 4201101.077

Classification nr.
 1st Character - grade 3 - Category of use: high frequency
 2nd Character - grade 7 - Durability: 200.000 cycles
 3rd Character - grade 7 - Mass of the door: over 200kg
 4th Character - grade B - Suitable for use on fire/smoke rated doors
 5th Character - grade 1 - Safety: suitable for emergency exits
 6th Character - grade 3 - Highly resistant to corrosion 96h
 7th Character - grade 2 - Safety of goods: 1000N
 8th Character - grade 2 - Protrusion of the device: up to 100mm
 9th Character - grade B - Activation type: touch bar
 10th Character - grade A - Suitable for 1 or 2 leaved door

Suitable for doors with one leaf or for the active leaf (primary) of two-leaved doors up to 1350x2880mm/leaf in size, a mass of up to 300kg/leaf, mounted on hinges or pivots, fire resistant up to EI²120 – REI120 and smoke proof. Protrusion of the exit bar: 75mm.

SYMBOLS EMPLOYED

- CAUTION**
Indicates a danger that threatens people and/or material goods. Failure to observe the warnings indicated by this symbol may have serious consequences, such as personal injury and property damage.
- ATTENTION**
Indicates a danger that threatens material goods. Failure to observe the warnings indicated by this symbol may result in damage to material goods.
- NOTICE**
Warnings related to important technical aspects.

PRODUCT DESCRIPTION

Panic bar for one-leaved doors or for the active leaf of two-leaved doors located at emergency exits and activated by touch-bar. Composed of galvanized steel controls, stainless steel carters, horizontal bar, external lever handle with cover plate and galvanized steel installation plate and nickel-plated brass cylinder with three keys.
 This product does not contain or release any hazardous materials, as per UNI EN standard nr. 1125 appendix ZA.

OPERATION MODE

While locked by key, the door cannot be opened from the pull side (handle side), while it can always be opened from the push side by using the horizontal bar of the SLASH INOX BM panic exit device.

WARNINGS

The SLASH panic bar activated by means of a horizontal bar is intended for use onto doors installed in escape routes where panic situations could develop. The safety features of this product are of fundamental importance to ensure its conformity with EN 1125. It is strictly forbidden to introduce any type of modifications apart from those described in these installation instructions.

RECOMMENDATIONS

In order to ensure that the panic bar could provide a high level of safety toward people and appropriate safety level toward goods, it should only be mounted onto doors and doorframes that are in good conditions. The door itself, therefore, should be checked to ensure that it was installed properly and that nothing obstructs its normal movement.

If door rebate sealing have been mounted on the door, make sure they do not inhibit proper functioning of the panic bar.

In case of two-leaved door where both leaves are equipped with panic bar, it is mandatory to check that each leaf opens when its respective panic bar is activated, and that leaves open freely when the bars are activated simultaneously.

The fastening instructions in the present document should be followed scrupulously during installation. Once installation is complete, the installer should give this document to the owner of the activity.

The horizontal bar should be installed in a way that maximizes its useable length.

For securing the door in the closed position, do not employ any other latching devices than those specified in the present document. This does not preclude the installation of automatic closing devices.

Different external access devices than those found on the list of certified components on pages 4/4 are considered unacceptable.

The SLASH panic bar is also designed for installation on hollow metal doors with an internal cell structure.

If a door closer is needed to return the door to the closed position, care should be taken not to make the opening step more difficult for children, the elderly and the disabled.

A pictogram (arrow) should be positioned immediately above the horizontal bar on the internal side of the door.

All of the included components described herein must be positioned and mounted in conformity with the present document.

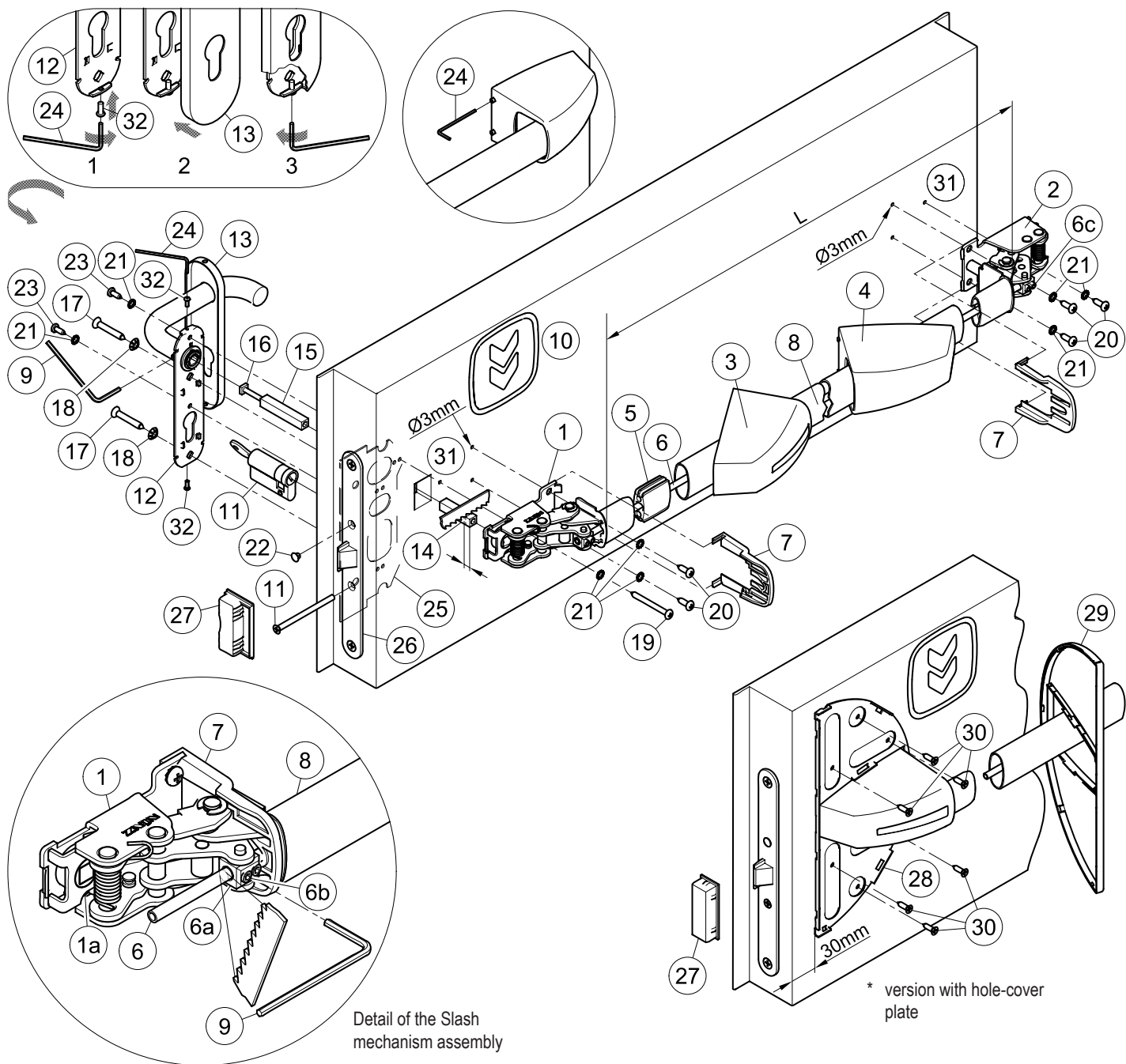



Detail of the Slash mechanism assembly

CONTENTS OF THE SLASH INOX BM PANIC BAR PACKAGE

position	pcs.	description
1, 2	01	Slash mechanism assembly
3, 4	01	Slash INOX carter set
5	01	Guide for connection pipe
6	01	Connection pipe
7	02	Protection
8	01	Horizontal bar in stainless steel
9	01	S3 hex key
10	01	Adhesive pictogram (green arrow)
11	01	Standard nickel-plated half cylinder with three keys and fastening screw
12	01	Stainless steel handle with galvanized steel installation plate and fastening socket set screw
13	01	Stainless steel cover plate
14, 15	01	Square spindle 9x9x(55+40)mm
16	01	M5 screw for threaded square spindle
17	02	Self-tapping countersunk screw Ø5,5x38mm

position	pcs.	description
18	02	M6 toothed washer
19	01	Pan head self-tapping screw, Ø4,8x50mm (Proget+Univer) or Ø4,8x38mm (Rever)
20	05	Pan head self tapping screw Ø4,8x16mm
21	08	M5 toothed washer
22	01	Black cap hole Ø8,8mm
23	02	Pan head self tapping screw Ø4,2x13mm
24	01	S2 hex key
28 *	01	Hole-covering base plate
29 *	01	Cover for hole-covering base plate – black
30 *	06	Self-drilling countersunk screw Ø4,2x16mm
32	02	M3x8mm pan head screw
-	01	A034 hole-drilling template
-	01	Slash INOX BM panic bar set installation instruction

 Please note that article 4 of the MD of 03 November 2004 obliges the installer to write up, sign and provide the owner of the activity with a declaration of proper installation that makes explicit reference to the instructions supplied by the exit device manufacturer.

 - The panic lock (26) and the respective strike box (counterstrike) (27) are delivered already mounted on the door as well as the subplate (25)!

TOOLS REQUIRED

Medium-sized Philips-head screwdriver or electric screwdriver, electric drill with Ø2 and Ø3mm drill bit for steel and hack-saw for stainless steel.

IMPORTANT

- Installation should be carried out by qualified personnel only and in strict conformity with the instructions supplied.
- For a correct installation all supplied components must be used, including toothed washers.
-  - No variations are allowed, and only components indicated in the package contents may be used.
- Given its purpose, the Slash INOX BM panic bar should be mounted on the push-side of the door.
- Before proceeding with installation, check the package contents to ensure that no pieces are missing.
- Check if the door is equipped with the panic safe lock and the subplate (25).
- Check the type of lever handle to apply and follow the specific instructions.
- Any different installation configuration from that illustrated on pag. 2/4 is not allowed.

INSTALLATION

- Insert the half cylinder (11) and fasten it temporarily with the screw (11) then remove the key. If the hole of the subplate (25) does not match with the half cylinder, take away the lock (26) and turn the subplate upside down.
- For Rever door adjust the threaded square spindle (14) reducing its length for 5mm; be careful to cut the bevelled side.
- Insert the square spindles (14 and 15) into the lock for connecting them by tightening the respective screw (16).
- Screw onto installation plate of handle (12) the screws (32), just enough to insert the cover plate (13).
- Approach the handle (12) to the leaf from pull-side taking care to centre the square spindle and fasten it with the screws (17) and their toothed washers (18) by centering the respective holes of the subplate (25).
- Use the template to drill the holes (31) with the Ø3mm drill bit, checking the level. If holes are already present, drill them again for the internal reinforcement.
- Insert the operating mechanism (1) of the panic bar, to the lock-side (push-side of the door), with the lift of the cam (1a) turned downwards, over the square spindle (14). Fasten the mechanism starting with the two Ø4,8x16mm screws (20), then with the Ø4,8x50mm (Proget/Univer) or Ø4,8x38mm (Rever) screw (19), with their toothed washers (21).
- In case of Univer and Rever doors, apply the hole-covering base plate (28) after having provisionally clipped on the carter (3) on the mechanism. Center it vertically above the carter and at a distance of 30mm from the edge of the leaf (see drawing). Fasten the hole-covering base plate provisionally with the two more external screws (30) by first drilling holes in the metal panel with the Ø2mm drill bit, then positioning the cover (29) to verify that it attaches correctly without interfering with the carter. If everything matches, complete fastening with the remaining screws (30) after removing the cover (29) and the carter (3).
- Fasten the mechanism (2) of the panic bar at hinged side, using the self-tapping screws Ø4,8x16mm (20) and their toothed washers (21).
- Make a precise "L" measurement, cut the stainless steel bar (8), and remove the burrs from the cut edge. Insert the guide (5) for the connection pipe in the center of the bar.
- Take out the mechanism (2) in order to insert the horizontal bar (8) in the operating mechanism (1); then insert also the connection pipe (6) until it passes through the block (6a).
- Insert the stainless steel carters in the horizontal bar, first the one with the sticker (3), then the other one without (4). For Univer or Rever doors insert also the cover (29) between the two carters. Join the bar with the hinged side mechanism (2) inserting also the connection pipe (6) before re-fastening the mechanism at the door.
- Fasten provisionally the connection pipe (6) so that it not protrudes from the block, by screwing the two socket set screws (6c) of the hinged side mechanism (2) with the S3 hex key (9).
- Maintaining pulled the horizontal bar (8) block the connection pipe (6) by screwing lightly the two socket set screws (6b) of the operating mechanism (1). Then verify that the latch bolt retracts completely by pushing the end of the bar from hinged side. In this case screw the four socket set screws (6b and 6c) until they not protrude from the block. Otherwise loosen the socket set screws and repeat the operation, making sure that the connection pipe is kept under tension. Lastly cut off the protruding piece of the connection pipe.
- Insert the protections (7) in the designated guides of both mechanisms.
- Apply the carters (3 and 4) on the relative mechanisms while ensuring that the protections (7) remain in their position. Clip on the carters by pushing softly the horizontal bar; first the narrow side, then the wide side. Finally fix the carters fastening their socket set screw without forcing, using the S2 hex key (24).

- Finish fastening the half cylinder (11), insert the little cap hole (22) in the open hole of the panic safe lock (26).



- Push the Slash INOX BM panic bar at any point along the horizontal bar, checking to ensure that the latch bolt of the central safe lock opens easily and fully. Use the same method to check the external handle and also the key. Test the door in both open and closed positions and if necessary, file down the plastic strike box (27) of one-leaved doors, or the panic safe lock for inactive leaf of two-leaved doors. In case of Proget door with three-point locking mechanism, the latch bolts of lock-levers and/or their strike box have to be considered too.
- Fasten the installation plate of handle (12) using the Ø4,2x13mm self-tapping screws (23) and their toothed washers (21) after drilling holes in the metal panel with the Ø2mm drill bit. Insert the cover (13) onto the handle (drw. 2). Using the S2 hex key (24) to unscrew the screws (32) until the cover become fixed, avoiding any deformations (drw. 3). Insert and fasten the socket set screw well with the S3 hex key (9).
- If present, the cover (29) has to be clipped on manually at the hole-covering base plate (28).
- Apply the pictogram (10) with the green arrow on the internal surface of the door, just above the horizontal bar.
-  - Lastly, use a dynamometer to measure the force required on the horizontal bar to release the lock. Record this force measurement in the present document.

USE





- Ensure that the door always opens easily.
- Avoid unnecessary strains on or handling onto handle and exit bar.
- Protect the panic bar from external atmospheric agents.
- Avoid anything that could hamper the free movement of the bar.
- Do not paint the lock and any lock-lever.
- Use the bar properly, do not pull it in the wrong direction.
- Do not leave the key in the lock.



- Make sure that any damaged or malfunctioning parts are replaced immediately.

MAINTENANCE

To ensure that door usage conforms with regulations, the following maintenance checks should be carried out at least once a month:

- Confirm that all of the installed components correspond with those listed in the present instructions and that no other latching devices than those originally installed have been added to the door.
- Inspect and activate the panic bar to verify that all of its components are in satisfactory operational condition.
- Use a dynamometer to confirm that the release force shows no significant differences from the forces recorded at the time of installation.
-  - Check whether all screws are fully tightened, tightening any that may have loosened.
- Check whether panic bar, handle and key can be moved with minimal effort, and that the latch bolt of the central safe lock retreats from the strike box without offering resistance. If the door has become difficult to open due to friction, the resistance can be reduced by filing the strike box down to the appropriate height. In case of Proget door with three-point locking mechanism, the latch bolts of lock-levers and/or their strike box have to be considered too.
- Activate the Slash INOX BM panic bar at both ends of the horizontal bar, checking to ensure full retraction of the latch bolt of the central safe lock and of any lock-levers in both cases.
- Ensure that the latch bolt of the central safe lock and of any lock-levers exits completely when the horizontal bar is released.
- Check the horizontal bar and replace it if any damage or deformities are detected.
-  - Check whether the inserts and strike boxes are blocked in any way and eliminate any obstructions.
- This product requires no special maintenance. Grease spray should be used to lubricate the internal workings of lock, lock-levers (for Proget door with three-point lock mechanism only), handle and panic bar on a regular basis – the latter has a hole on its carter for this purpose.
- For normal cleaning, use a cleaning agent designed specifically for stainless steel.
-  - Any adjustments that become necessary must be carried out by qualified personnel using original NINZ replacement parts.
-  - The owner of the activity is responsible for keeping the declaration of correct installation on file, conducting proper panic bar maintenance in accordance with all of the manufacturer's maintenance guidelines, keeping maintenance and check-up records and preserving the present document.

 ATTESTATO DI CONFORMITÀ DIRETTIVA 89/106/CEE CERTIFICATE OF CONFORMITY DIRECTIVE 89/106/CEE		 0425
<small>Questo certificato è rilasciato in conformità a quanto prescritto dall'Art.6 par.2 lettera b) del DPR 21 aprile 1993, n°246 (Direttiva 89/106/CEE) ed attesta la conformità del prodotto di seguito identificato agli Art.1, Art.2 ed allegato A del DPR 21 aprile 1993, n°246 (Direttiva 89/106/CEE) This certificate has been issued in conformity to what prescribed by the Art.6 par.2 letter b) of the DPR 21/04/1993, n°246 (Directive 89/106/EEC) and certifies the conformity of the product described below to the Art.1, Art.2 and attachment A of DPR 21/04/1993, n°246 (Directive 89/106/EEC)</small>		
ATTESTATO N°	1308 - CPD - 2007	CERTIFICATE N°
Organismo notificato		Notified Body
ICIM S.p.A. - Piazza Don Mapelli, 75 - 20099 Sesto San Giovanni (MI) ITALY		Identification number: 0425
Dati Fabbricante		Manufacturer
Sede legale NINZ S.p.A. Corso Trento, 2/A 38061 ALA (TN) ITALY		Head office
Unità operativa		Operative unit
Dati prodotto		Product
Tipologia	DISPOSITIVI ANTIPANICO PER USCITE DI SICUREZZA AZIONATI MEDIANTE UNA BARRA ORIZZONTALE PANIC EXIT DEVICES	Type
Denominazione	Dispositivo antipanico Modelli "SLASH", "SLASH ART", "SLASH ALU", "SLASH INOX", "SLASH INOX AR", "SLASH INOX AR" Serrature antipanico art. AP1618, SCA 1 3201001.019/020, MAC 1 3201001.041/042, 3201001.018, 485-65-0. Controserrature antipanico art. AP020P, AP020U, 3201001.6, 43190-95. Dispositivo superiore art. 3105080, 3105024, 3305003. Riscontro asta art. 2401036, 2401046, 2401044, 2401002. Boccola pavimento art. 2401001, 2401007, 3105091, 2401020, 4419008. Deviatori art. 4201010. Aste verticali art. 3305016, 3305016, 3305002, 3305013, 990837. Riscontro serratura art. 2401006, 2401005, 2401015, 2401014, 2401006, 2401036, 3412001. Comandi esterni art. BM, BSP, BS, BMC, BC, B, A, BM inox, BM alu, BSP inox, BSP alu.	Denomination
Sistema di attestazione della conformità	1	Attestation of conformity
Norma di riferimento	EN1125:2008	Standard
Classificazione	3 7 7 B 1 3 2 2 B A	Classification
Eventuali estensioni	Nessuna / None	Extensions
Eventuali condizioni di subordinazione della Certificazione CE	Nessuna / None	Possible conditions of subordination of the CE Certification
<small>Il presente attestato è valido esclusivamente per il prodotto indicato. Eventuali varianti da apportare devono essere approvate da ICIM SpA The present issue is valid only for the product described above. Possible changes to be brought in have to be approved by ICIM S.p.A.</small>		
Data di emissione First issue	Emissione corrente Current issue	Data di scadenza Expiring date
31/05/2007	04/08/2010	30/05/2017
		 ICIM S.p.A. Il Presidente Ing. Tullio Badino

SPARE PARTS (see exploded drawing at page. 2/4)

position	code	description
1, 2, 3, 4, 5, 7, 10	3102066.001	Slash INOX latch case
1, 2	3105119.001	Slash assembly mechanism
3, 4	3105175.001	Slash INOX carter set
5, 7	3105130.001	Slash 2 protections + 1 plastic piece set
6, 8	4204017.001	Stainless steel bar set
9, 12, 13, 14, 15, 16, 17, 18, 19, 20, 21, 22, 23, 24, 32	4211102.021	Slash BM set – stainless steel
11	4202103.001	Standard nickel-plated half cylinder 40/10 for Proget/Univer thk 60mm
11	4202103.002	35/10 for Univer thickness 50mm
11	4202103.003	30/10 for Rever
25	3407013.001	Reinforcement plate
26	3201001.016	Panic safe lock to push (AP 16/18)
27	4212024.001	Set of 10 Proget strike box lock
27	4212025.001	Set of 10 Univer thk60 strike box lock
27	4212026.001	Set of 10 Univer thk50 strike box lock
27	4212027.001	Set of 10 Rever strike box lock
* 28, 29, 30	4204020.002	Slash hole cover + base plate + screws – finishing: black

Certified components for SLASH INOX BM

- Panic exit device: series "SLASH INOX"
- Panic safe lock: item AP 16/18, MAC 1 3201001.041/042, 3201001.018
- Lock strike box: item 2401006, 2401005, 2401015, 2401014
- External control: item BM inox, ELECTRIC HANDLE

 **FOR REPLACEMENTS USE ORIGINAL NINZ REPLACEMENT PARTS FROM ITS FULL CERTIFIED SYSTEM ONLY!**

PROPER DISASSEMBLY

When some parts or all of the panic bar needs to be replaced, the general guideline is to reverse the order of the original installation instructions. To replace the lock, all parts of the panic bar in the locking device zone must be disassembled, including the external handle. The lock itself (26) can be removed by unscrewing the two frontal screws.

 This operation should be carried out with great care in order not to damage or move the components located inside lock housing!

MAINTENANCE RECORD			
date	description of the intervention	release force checked	operator

 These instructions should be given to the owner of the activity, who must preserve them as a record of the maintenance operations carried out on the panic bar.