



NINZ S.p.A. - corso Trento, 2/A
I-38061 ALA (TN) / ITALY www.ninz.it
Tel. + 39 0 464 678300
Fax. +39 0 464 679025 info@ninz.it

KIT EXUS LP A
PANIC EXIT DEVICE
for emergency exits

A085-GB

5001181/1 - 02/19

Commercial codes
 4204302.001 KIT EXUS LP A for PROGET doors

Name and address of the producer
 NINZ S.p.A. - corso Trento 2/A
 I-38061 ALA (TN) - ITALIA

Year application trademark
 2007

Standard
 EN 1125:2008 + EC1:2009

Certification authority no.
 0425

CE certification no. 0425-CPR-001228





DoP no. **1125-TW-EX-01**
 Website <https://www.ninz.it/it/download/dop>
 Classification 3 7 7 B 1 3 2 1 A A

Classification nr.
 1st Character - grade 3 - Category of use: high frequency
 2nd Character - grade 7 - Durability: 200.000 cycles
 3rd Character - grade 7 - Mass of the door: over 200kg
 4th Character - grade B - Suitable for use on fire/smoke rated doors
 5th Character - grade 1 - Safety: suitable for emergency exits
 6th Character - grade 3 - Highly resistant to corrosion 96h
 7th Character - grade 2 - Safety of goods: 1000N
 8th Character - grade 1 - Protrusion of the exit bar: up to 150mm
 9th Character - grade A - Activation type: push bar
 10th Character - grade A - Suitable for 1 or 2 leaved door

Suitable for doors with one leaf or for the active leaf (primary) of two-leaved doors up to 1350x2880mm/leaf in size, a mass of up to 300kg/leaf, mounted on hinges or pivots, fire resistant up to EI²120 – REI120 and smoke proof. Protrusion of the exit bar: 125mm.

SYMBOLS EMPLOYED

-  **CAUTION**
 Indicates a danger that threatens people and/or material goods. Failure to observe the warnings indicated by this symbol may have serious consequences, such as personal injury and property damage.
-  **ATTENTION**
 Indicates a danger that threatens material goods. Failure to observe the warnings indicated by this symbol may result in damage to material goods.
-  **NOTICE**
 Warnings related to important technical aspects.

PRODUCT DESCRIPTION

Panic bar for one-leaved doors or for the active leaf of two-leaved doors located at emergency exits and activated by push-bars. Composed of galvanized steel controls, black plastic casing and lever, horizontal aluminium bar, external lever handle, panic lock and nickel-plated brass cylinder with three keys. This product does not contain or release any hazardous materials, as per UNI EN standard nr. 1125 appendix ZA.

OPERATION MODE

While locked by key, the door cannot be opened from the pull side (handle side), while it can always be opened from the push side by using the horizontal bar of the EXUS LP BM panic exit device.

WARNINGS

The EXUS panic bar activated by means of a horizontal bar is intended for use onto doors installed in escape routes where panic situations could develop. The safety features of this product are of fundamental importance to ensure its conformity with EN 1125. It is strictly forbidden to introduce any type of modifications apart from those described in these installation instructions.

RECOMMENDATIONS

In order to ensure that the panic bar could provide a high level of safety toward people and appropriate safety level toward goods, it should only be mounted onto doors and doorframes that are in good conditions. The door itself, therefore, should be checked to ensure that it was installed properly and that nothing obstructs its normal movement.

If door rebate sealing have been mounted on the door, make sure they do not inhibit proper functioning of the panic bar.

 In case of two-leaved door where both leaves are equipped with panic bar, it is mandatory to check that each leaf opens when its respective panic bar is activated, and that leaves open freely when the bars are activated simultaneously.

The fastening instructions in the present document should be followed scrupulously during installation. Once installation is complete, the installer should give this document to the owner of the activity.

The horizontal bar should be installed in a way that maximizes its useable length.

For securing the door in the closed position, do not employ any other latching devices than those specified in the present document. This does not preclude the installation of automatic closing devices.

Different external access devices than those found on the list of certified components on pages 4/4 are considered unacceptable.

The EXUS panic bar is also designed for installation on hollow metal doors with an internal cell structure.

If a door closer is needed to return the door to the closed position, care should be taken not to make the opening step more difficult for children, the elderly and the disabled.

A pictogram (arrow) should be positioned immediately above the horizontal bar on the internal side of the door.

 All of the included components described herein must be positioned and mounted in conformity with the present document.

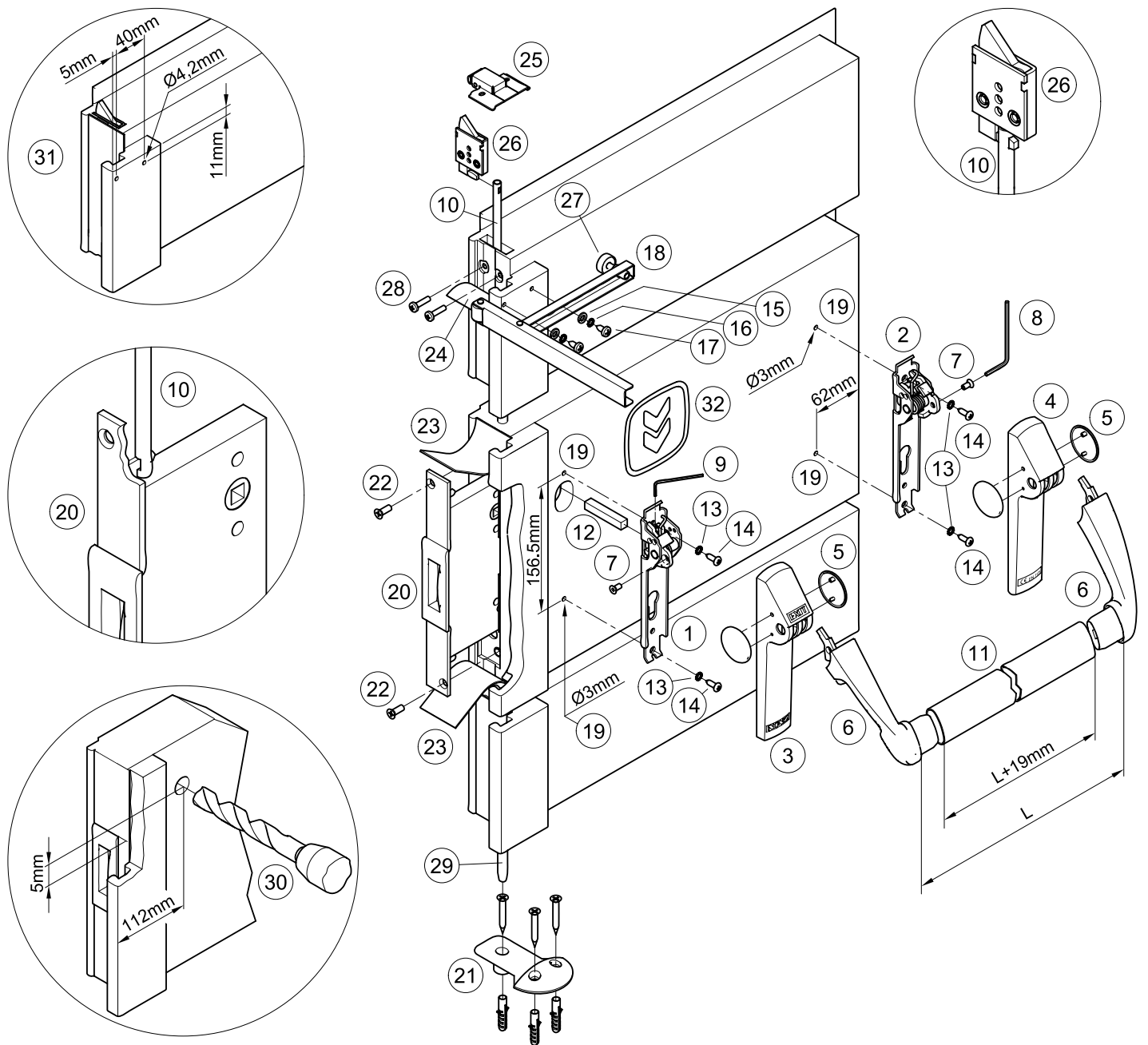

CONTENTS OF THE EXUS LP A PANIC BAR PACKAGE

position	pcs.	description	position	pcs.	description
1, 2	01	Twist/Exus mechanism assembly	15	02	Washer
3, 4, 5	01	Twist/Exus LP carter set with plugs	16	02	Toothed washer
6	01	Exus LP set carrier arms	17	02	Pan head self tapping screw Ø5,5x13mm
7	02	M5x10mm hex socket countersunk screw	18, 27	01	Carrier arm
8	01	S3 hex key	20	01	Panic safe lock for passive leaf
9	01	S2 hex key	21	01	Proget floor catch with 3 plastic anchors
11	01	Horizontal bar in anodized aluminium	26, 28	01	Upper bolt-device with screw
12	01	Square spindle 9x9x52mm	32	01	Adhesive pictogram (green arrow)
13	04	Toothed washer	-	01	A034 hole-drilling template
14	04	Pan head self tapping screw Ø4,8x16mm	-	01	Exus LP A Proget panic bar installation instructions

N.B. before mounting the panic exit device the leaf has to be prepared following the installation instructions.

 Please note that article 4 of the MD of 03 November 2004 obliges the installer to write up, sign and provide the owner of the activity with a declaration of proper installation that makes explicit reference to the instructions supplied by the exit device manufacturer.



TOOLS REQUIRED



Medium-sized Philips-head screwdriver or electric screwdriver, electric drill with Ø3, Ø4,2 and Ø20mm drill bit for steel, hack-saw for aluminium.

IMPORTANT

- Installation should be carried out by qualified personnel only and in strict conformity with the instructions supplied.
- For a correct installation all supplied components must be used, including toothed washers.
-  - No variations are allowed, and only components indicated in the package contents may be used.
- Given its purpose, the Exus LP A panic bar should be mounted on the push-side of the inactive leaf and the active leaf has to be fitted with an Exus LP panic exit device, too.
- Before proceeding with installation, check the package contents to ensure that no pieces are missing.
- Any different installation configuration from that illustrated on pag. 2/4 is not allowed.

INSTALLATION

- To make the work easier, it is best (though not required) to lay the passive (secondary) leaf horizontally across two work benches.
- First disassemble any handles or bar components that are already present.
- Remove the existing panic safe lock (20) by unscrewing the two frontal screws (22) after first detaching the thermo-expanding gasket (23) that is glued over them.
- Remove the present upper bolt-device (26) by unscrewing the two frontal screws (28). In case of fire-rated doors detach first the thermo-expanding gasket (24) that is glued over the screws. The upper bolt-device must be unthread from the central joint dragging with it also the upper vertical connecting rod (10).
- Install the new upper bolt-device (26) included in the supplied KIT, bring the rod (10) and the device (26) in the right position and re-fasten all with the two M5x20mm screws (28).
-  - Install the new panic safe lock (20), making sure to center the square hole of both rods. The operation should be carried out with great care, making sure not to ruin or displace any of the components inside the lock housing. Attention: the hole for the square spindle on the lock mechanism should be turned towards the upper part of the door. Reuse the two M6x16mm screws (22) for the fastening of the panic safe lock. Ensure that the two rods are attached and can move freely.
- In case of fire-rated doors re-glue the thermo expanding gasket (23 and 24), if necessary by using a common silicone and refit the leaf correctly on the frame.
- If not already installed, apply the floor catch (21) by attaching it with the appropriate screws and fasteners according to the door installation instructions.
- Continue with installing the panic exit device and if no hole should have been provided for the passage of the square spindle (12), drill the hole in the metal panel at the push-side of the door at the position indicated in figure (30) by using the Ø20mm drill bit.
- Use the template to drill the holes (19) with the Ø3mm drill bit, checking the level. Drill the holes in each case also in the internal reinforcement.
-  - Insert the square spindle (12) in the operating mechanism (1) until it touches the spring, then fasten it with the threaded pin by using the S2 hex key (9).
- Center the square spindle (12) correctly into the hole of the lock (20) while approaching the mechanism (1) until it touches the metal panel of the leaf, fasten it by tightening the Ø4,8x16mm self-tapping screws (14) and their toothed washers (13).
- Fasten the mechanism (2) of the panic bar at hinged side, using the self-tapping screws Ø4,8x16mm (14) and their toothed washers (13).
- Put the plastic carter with "EXIT" wording (3) on the operating mechanism (1) and the other one (4) on the hinged side mechanism (2), snapping them on manually.
- Apply the carrier arms (6) and fasten them with the dedicated screws (7), tightening them securely with the included S3 wrench (8).
- Make a precise "L" measurement, cut the aluminium bar (11) adding 19mm and remove the burrs from the cut edge. Remove one carrier arm, attach the bar and re-fasten the entire assembly.
- Apply the plugs (5).
- If not yet present, drill the two holes (31) with the Ø4,2mm drill bit at a distance of 11mm from the upper edge of the central joint and 40mm apart from each other. The first hole has to be drilled 5 mm away from the lateral edge as shown in drawing.



- Apply the carrier arm (18) as shown in the drawing, fastening it with the two 5,5x13mm self-tapping screws (17) and their washers (15 and 16).
- Adjust the rubber spacer (27) so that it rests correctly on the leaf.
- Adjust the position of the carrier arm so that using the horizontal bar of the passive leaf causes that the active leaf is pushed just enough to ensure the correct closing sequence for the two leaves (active leaf held in waiting position by the closing regulator).
-  - Push the Exus LP A panic bar at any point along the horizontal bar to check the complete exit of the counter-latchbolt and the full retraction of the upper bolt-device (26) as well as the lower rod (29). Test the door in both open and closed positions. In case of fire-rated doors verify that the self-closing sequence of the two leaves operates properly.
- Apply the pictogram (32) with the green arrow on the internal surface of the door, just above the horizontal bar.
-  - Lastly, use a dynamometer to measure the force required on the horizontal bar of the Exus LP A panic exit device to free the passive leaf from the latch bolt of the lock, from the upper bolt-device and from the lower rod. Record this force measurement in the present document.



USE

- Ensure that the leaf always opens easily.
- Avoid unnecessary strains on or handling of the exit bar.
- Protect the panic bar from external atmospheric agents.
- Avoid anything that could hamper the free movement of the bar.
- Do not paint the panic safe lock of the passive leaf, neither the upper bolt-device, neither the tip of the lower rod and its respective guide.
- Use the bar properly, do not pull it in the wrong direction.
-  - Make sure that any damaged or malfunctioning parts are replaced immediately.

MAINTENANCE

To ensure that door usage conforms with regulations, the following maintenance checks should be carried out at least once a month:

- Confirm that all of the installed components correspond with those listed in the present instructions and that no other latching devices than those originally installed have been added to the door.
- Inspect and activate the panic bar to verify that all of its components are in satisfactory operational condition.
- Use a dynamometer to confirm that the release force shows no significant differences from the forces recorded at the time of installation.
-  - Check whether all screws are fully tightened, tightening any that may have loosened.
- Push the panic bar at any point along the horizontal bar to check the complete exit of the counter-latchbolt and the full retraction of the upper bolt-device (26) as well as the lower rod (29). Test the door in both open and closed positions.
- Once released the horizontal bar and closed the leaf, verify that the counter-latchbolt retracts fully as well as the upper bolt-device and lower rod exit completely.
- In case of fire-rated doors open the two leaves by acting on the exit bar of the secondary leaf and verify the correct closing sequence of the two doors.
- Check the horizontal bar and replace it if any damage or deformities are detected.
-  - Ensure that the upper strike box with roller and floor catch are not blocked; if so, remove the obstruction.
- The product requires no special maintenance. Grease spray should be used to lubricate the upper bolt-device, the lower rod guide, internal workings of the lock and panic bar on a regular basis – the latter has a hole on its carter for this purpose, located below the carrier arms.
- For normal cleaning use mild detergents.

-  - Any adjustments that become necessary must be carried out by qualified personnel using original NINZ replacement parts.
-  - The owner of the activity is responsible for keeping the declaration of correct installation on file, conducting proper exit bar maintenance in accordance with all of the manufacturer's maintenance guidelines, keeping maintenance and check-up records and preserving the present document.

