

- 1) Identification code: **EXUS LX PANIC EXIT DEVICE**
- 2) Identification number: 4204302.009      KIT EXUS LX A for REVER and UNIVER doors - multipurpose
- 3) Intended product use: Panic exit device for escape routes suitable for the inactive leaf of two-leaved doors with dimensions up to 1350x2880mm/leaf, mass up to 300kg/leaf, mounted on hinges or pivots, with fire resistance up to EI<sub>2</sub>120 - REI120 and smoke proof. Projection of the bar 125mm.
- 4) Manufacturer: NINZ S.p.A. - corso Trento 2/A  
I-38061 ALA (TN)      www.ninz.it  
tel. +39 0464 678300 - fax +39 0464 679025
- 5) Auth. representative: -
- 6) Assessment perf. sys.: system 1
- 7) Harmonized standard: EN 1125:2008 + EC1:2009
- 8) Notified body: ICIM S.p.A. N.B. nr. 0425 have issued the certificate of conformity for the factory production control nr. 0425 CPR 001228.

- 9) Declared performances:
- | Essential characteristics               | Performance-grade       | Paragraph EN 1125 |
|---|-------------------------|-------------------|
| Category of use                         | 3 - high frequency      | 7.1               |
| Durability                              | 7 - 200.000 cycles      | 7.2               |
| Door mass                               | 7 - over 200kg          | 7.3               |
| Suitability for use on fire/smoke doors | B - suitable            | 7.4               |
| Safety toward people                    | 1 - for escape routes   | 7.5               |
| Corrosion resistance                    | 3 - 96 h (high resist.) | 7.6               |
| Security toward goods                   | 2 - 1000N               | 7.7               |
| Projection of horizontal bar            | 1 - up to 150mm         | 7.8               |
| Type of horizontal bar operation        | A - push-bar            | 7.9               |
| Field of door application               | A - 1 or 2 leaved door  | 7.10              |
| Dangerous substances                    | conform                 | ZA                |
- 10) Panic bars listed in point 1 and 2 are conform to the performances declared in point 9. This declaration of performance is issued under the exclusive responsibility of the manufacturer listed in point 4.

Signed in the name and on behalf of the manufacturer:

Ninz Karl  
legal representative of the NINZ S.p.A.

## INSTALLATION, USE AND MAINTENANCE HANDBOOK

**A102-GB**  
5001199/2 - 02/19

### SYMBOLS EMPLOYED

- CAUTION**  
Indicates a danger that threatens people and/or material goods. Failure to observe the warnings indicated by this symbol may have serious consequences, such as personal injury and property damage.
- ATTENTION**  
Indicates a danger that threatens material goods. Failure to observe the warnings indicated by this symbol may result in damage to material goods.
- NOTICE**  
Warnings related to important technical aspects.

### PRODUCT DESCRIPTION

Panic bar for the inactive leaf of two-leaved doors located at emergency exits and activated by push-bars. Composed of stainless steel controls, casing, lever and horizontal bar and also panic safe lock, vertical rods, upper bolt-device, upper strike box with roller and floor catch.

### OPERATION MODE

The EXUS LX A panic exit device is always used in combination with another EXUS LX panic exit device applicated at the active leaf and therefore no external control is expected. From push-side opening is possible at any time by pushing the horizontal bar which draws back the vertical rods and at the same time pushes back the latch bolt of the active leaf, so that both leaves are free.

### WARNINGS

The EXUS panic bar activated by means of a horizontal bar is intended for use onto doors installed in escape routes where panic situations could develop. The safety features of this product are of fundamental importance to ensure its conformity with EN 1125. It is strictly forbidden to introduce any type of modifications apart from those described in these installation instructions.

If the REVER/UNIVER door is not prepared for the application of the panic exit device or an already mounted panic bar must be replaced because of a failure or because of lack of CE certification, all components must be replaced following the present installation instructions and drawings.

### RECOMMENDATIONS

In order to ensure that the panic bar could provide a high level of safety toward people and appropriate safety level toward goods, it should only be mounted onto doors and doorframes that are in good conditions. The door itself, therefore, should be checked to ensure that it was installed properly and that nothing obstructs its normal movement.

If door rebate sealing have been mounted on the door, make sure they do not inhibit proper functioning of the panic bar.

It is mandatory to check that each leaf opens when its respective panic bar is activated, and that leaves open freely when the bars are activated simultaneously.

The fastening instructions in the present document should be followed scrupulously during installation. Once installation is complete, the installer should give this document to the owner of the activity.

The horizontal bar should be installed in a way that maximizes its useable length. For securing the door in the closed position, do not employ any other latching devices than those specified in the present document. This does not preclude the installation of automatic closing devices.

The EXUS panic bar is also designed for installation on hollow metal doors with an internal cell structure.

If a door closer is needed to return the door to the closed position, care should be taken not to make the opening step more difficult for children, the elderly and the disabled.

A pictogram (arrow) should be positioned immediately above the horizontal bar on the internal side of the door.

All of the included components described herein must be positioned and mounted in conformity with the present document.

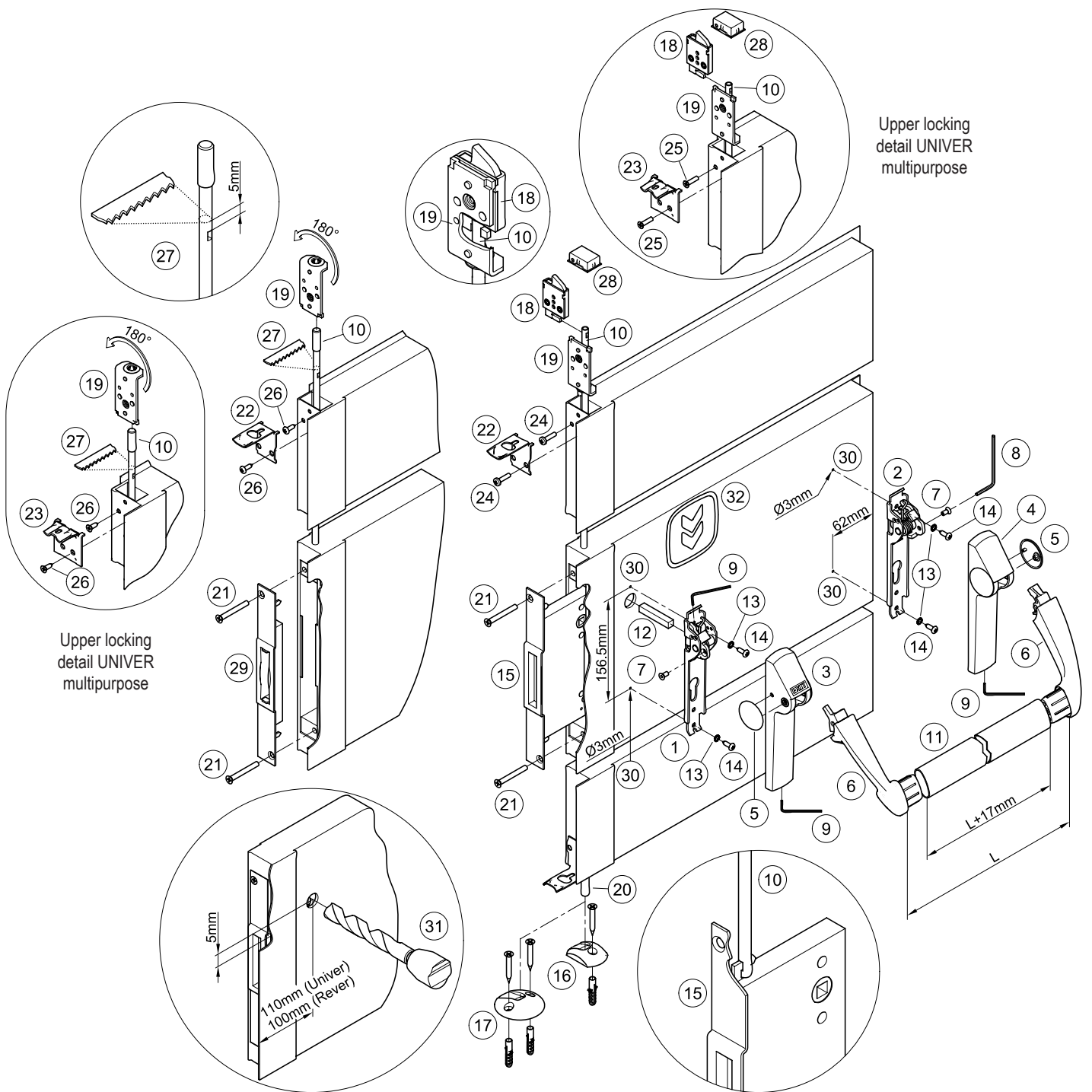

### CONTENTS OF THE EXUS LX A PANIC BAR PACKAGE

position	pcs.	description	position	pcs.	description
1, 2	01	Exus LX mechanism assembly in stainless steel	17	01	Univer floor catch with 2 plastic anchors
3, 4, 5	01	Exus LX carter set with plugs	18	01	Upper bolt-device with screw
6	01	Exus LX set carrier arms	24	02	M5x20mm galvanized Philips-head pan head screw (for REVER door)
7	02	M5x10mm hex socket countersunk screw	25	02	M5x20mm black galvanized Philips-head countersunk screw (for UNIVER door)
8	01	S3 hex key	32	01	Adhesive pictogram (green arrow)
9	01	S2 hex key	-	01	A034 hole-drilling template
11	01	Horizontal bar in stainless steel	-	01	Exus LX A Rever and multipurpose Univer panic bar installation instructions
12	01	Square spindle 9x9x52mm			
13	04	Toothed washer			
14	04	Pan head self tapping screw Ø4,8x16mm			
15	01	Panic safe lock for passive leaf			
16	01	Rever floor catch with 1 plastic anchor			

N.B. before mounting the panic exit device the leaf has to be prepared following the installation instructions.



Please note that article 4 of the MD of 03 November 2004 obliges the installer to write up, sign and provide the owner of the activity with a declaration of proper installation that makes explicit reference to the instructions supplied by the exit device manufacturer.



**TOOLS REQUIRED**  
 Medium-sized Philips-head screwdriver or electric screwdriver, medium-sized screwdriver, electric drill and Ø3 and Ø20 mm drill bit for steel, hack-saw for stainless steel.

## IMPORTANT

- Installation should be carried out by qualified personnel only and in strict conformity with the instructions supplied.
- For a correct installation all supplied components must be used, including toothed washers.
-  - No variations are allowed, and only components indicated in the package contents may be used.
- Given its purpose, the Exus LX A panic bar should be mounted on the push-side of the inactive leaf and the active leaf has to be fitted with an Exus LX panic exit device, too.
- Before proceeding with installation, check the package contents to ensure that no pieces are missing.
- Any different installation configuration from that illustrated on pag. 2/4 is not allowed.
- If the door is not yet installed and to avoid any other adaptation operations, it is recommended to define the opening direction at every beginning so that changing operations of the opening direction listed in the installation instructions of the door itself can be executed at the same time. As standard the door is prepared for right hand opening to pull.

## INSTALLATION

- To make the work easier, it is best (though not required) to lay the passive (secondary) leaf horizontally across two work benches.
- First disassemble any handles or bar components that are already present.
- Remove the existing panic safe lock (29) by unscrewing the two frontal screws (21).
- The upper vertical rod (10) must be unthread from the central joint dragging with it also the corner steel of the rod (19) by unscrewing the two frontal screws (26) and removing, if present, also the frame-assembling bracket (22 or 23).
- Remove the upper and lower rod-guiding bushings in plastic from the inside of the lock housing by using a flat-blade screwdriver.
- Cut the spindle of the upper vertical rod (10) at 5mm from the buttonhole (27).
- Place the upper bolt-device (18) included in the KIT, join rod (10), corner steel of the rod (19) turned for 180° and bracket (22 or 23) in the right position and rescrew all with the two M5x20 mm screws (24 or 25). The lower vertical rod (20) remains unchanged.
-  - Install the new panic safe lock (15), making sure to center the square hole of both rods. The operation should be carried out with great care, making sure not to ruin or displace any of the components inside the lock housing. Attention: the hole for the square spindle on the lock mechanism should be turned towards the upper part of the door. Reuse the two M6x50mm screws (21) for the fastening of the panic safe lock. Ensure that the two rods are attached and can move freely.
- If not already installed, apply the floor catch (16 or 17) by attaching it with the appropriate screws and fasteners according to the door installation instructions.
- Continue with installing the panic exit device and if no hole should have been provided for the passage of the square spindle (12), drill the hole in the metal panel at the push-side of the door at the position indicated in figure (31) by using the Ø20mm drill bit.
- Use the template to drill the holes (30) with the Ø3mm drill bit, checking the level. Drill the holes in each case also in the internal reinforcement.
-  - Insert the square spindle (12) in the operating mechanism (1) until it touches the spring, then fasten it with the threaded pin by using the S2 hex key (9).
- Center the square spindle (12) correctly into the hole of the lock (15) while approaching the mechanism (1) until it touches the metal panel of the leaf, fasten it by tightening the Ø4,8x16mm self-tapping screws (14) and their toothed washers (13).
- Fasten the mechanism (2) of the panic bar at hinged side, using the self-tapping screws Ø4,8x16mm (14) and their toothed washers (13).
- Remove the externally-facing plugs (5) from both carter (3 and 4). To do this, insert a finger inside the carter and push the plug out, being careful not to remove the plastic insert. Apply the carter with "EXIT" wording (3) on the operating mechanism (1) and the other one (4) on the mechanism from hinged side (2). Do not fasten the socked set screws, so as to let the two carter movable.
- Apply the carrier arms (6) and fasten them with the dedicated screws (7), tightening them securely with the included S3 wrench (8).



- Make a precise "L" measurement, cut the stainless steel bar (11) adding 17mm, and remove the burrs from the cut edge. Remove one carrier arm, attach the bar and re-fasten the entire assembly.
- Finish fastening of the two carter (3 and 4), screw on without overtighten the socked set screw, using the S2 hex key (9), then apply the plugs (5).
-  - Push the Exus LX A panic bar at any point along the horizontal bar to check the complete exit of the counter-latchbolt and the full retraction of the upper bolt-device (18) as well as the lower rod (20). Test the door in both open and closed positions.
- Apply the pictogram (32) with the green arrow on the internal surface of the door, just above the horizontal bar.
-  - Lastly, use a dynamometer to measure the force required on the horizontal bar of the Exus LX A panic exit device to free the passive leaf from the latch bolt of the lock, from the upper bolt-device and from the lower rod. Record this force measurement in the present document.



## USE

- Ensure that the leaf always opens easily.
- Avoid unnecessary strains on or handling of the exit bar.
- Protect the panic bar from external atmospheric agents.
- Avoid anything that could hamper the free movement of the bar.
- Do not paint the panic safe lock of the passive leaf, neither the upper bolt-device, neither the tip of the lower rod and its respective guide.
- Use the bar properly, do not pull it in the wrong direction.
-  - Make sure that any damaged or malfunctioning parts are replaced immediately.

## MAINTENANCE

To ensure that door usage conforms with regulations, the following maintenance checks should be carried out at least once a month:

- Confirm that all of the installed components correspond with those listed in the present instructions and that no other latching devices than those originally installed have been added to the door.
- Inspect and activate the panic bar to verify that all of its components are in satisfactory operational condition.
- Use a dynamometer to confirm that the release force shows no significant differences from the forces recorded at the time of installation.
-  - Check whether all screws are fully tightened, tightening any that may have loosened.
- Push the panic bar at any point along the horizontal bar to check the complete exit of the counter-latchbolt and the full retraction of the upper bolt-device (18) as well as the lower rod (20). Test the door in both open and closed positions.
- Once released the horizontal bar and closed the leaf, verify that the counter-latchbolt retracts fully as well as the upper bolt-device and lower rod exit completely.
- Check the horizontal bar and replace it if any damage or deformities are detected.
-  - Ensure that the upper strike box with roller and floor catch are not blocked; if so, remove the obstruction.
- The product requires no special maintenance. Grease spray should be used to lubricate the upper bolt-device, the lower rod guide, internal workings of the lock and panic bar on a regular basis – the latter has a hole on its carter for this purpose, located below the carrier arms.
- For normal cleaning, use a cleaning agent designed specifically for stainless steel.

-  - Any adjustments that become necessary must be carried out by qualified personnel using original NINZ replacement parts.
-  - The owner of the activity is responsible for keeping the declaration of correct installation on file, conducting proper exit bar maintenance in accordance with all of the manufacturer's maintenance guidelines, keeping maintenance and check-up records and preserving the present document.



**SPARE PARTS** (see exploded drawing at page. 2/4)

position	code	description
1, 2, 3, 4, 5, 6, 7, 8, 32	3102061.001	Exus LX latch case – stainless steel
1, 2	3105127.001	Exus LX assembly mechanism – stainless steel
3, 4, 5	3105163.001	Exus LX carter set with plugs
6	3105140.001	Exus LX set carrier arm
7, 8	3105026.001	Twist/Exus bag
11	4204016.001	Stainless steel bar set
9, 12, 13, 14, 17	4211101.042	Twist/Exus A set Univer
9, 12, 13, 14, 16	4211101.043	Twist/Exus A set Rever
15	3201001.008	Panic safe lock for inactive leaf of Rever and Univer multipurpose doors – AP020U
18, 24, 25	3105024.001	Upper bolt-device with screws – inactive leaf Rever and Univer
10	3305015.001	Upper rod (indicate the wall opening height FMH / WOH) – Proget, Univer and Rever
19	4212029.001	Set of 5 rod-guide corner zone for double leaf door
20	3305002.001	Lower rod (indicate wall opening height FMH / WOH) – Univer and Rever
28	4212028.001	Set of 10 plastic strike box with roller – Rever and Univer

FOR REPLACEMENTS USE ORIGINAL NINZ REPLACEMENT PARTS FROM ITS FULL CERTIFIED SYSTEM ONLY!

**PROPER DISASSEMBLY**

When some components or the entire panic exit device need to be replaced, the general approach is to reverse the order of the original installation instructions. Replacement of the panic safe lock first requires that all parts of the panic bar in the lock zone be disassembled. To remove the panic safe lock (15) unscrew the two frontal screws.

The operation should be carried out with great care, being sure not to ruin or displace any of the components inside the lock housing and re-attaching the rods with great care!

**Certified components for EXUS LX A**

Panic exit device:	serie "EXUS LX"
Panic safe lock inactive leaf:	art. AP 020U
Upper bolt-device:	art. 3105024
Strike box (upper rod):	art. 2401044
Floor catch:	art. 2401020, 2401007
Vertical rods:	art. 3305015, 3305002
External controls:	art. A

**MAINTENANCE RECORD**

date	description of the intervention	release force checked	operator
.....	.....	.....	.....
.....	.....	.....	.....
.....	.....	.....	.....
.....	.....	.....	.....
.....	.....	.....	.....
.....	.....	.....	.....
.....	.....	.....	.....
.....	.....	.....	.....
.....	.....	.....	.....
.....	.....	.....	.....
.....	.....	.....	.....

These instructions should be given to the owner of the activity, who must preserve them as a record of the maintenance operations carried out on the panic bar.