

1) Identification code: **TWIST PANIC EXIT DEVICE**

2) Identification number: 4204301.033 KIT TWIST BS

3) Intended product use: Panic exit device for escape routes suitable for one-leaved doors or for the active leaf of two-leaved doors with dimensions up to 1350x2880mm/leaf, mass up to 300kg/leaf, mounted on hinges or pivots, with fire resistance up to EI₂120 - REI120 and smoke proof. Projection of the bar 100mm.

4) Manufacturer: NINZ S.p.A. - corso Trento 2/A
I-38061 ALA (TN) www.ninz.it
tel. +39 0464 678300 - fax +39 0464 679025

5) Auth. representative: -

6) Assessment perf. sys.: system 1

7) Harmonized standard: EN 1125:2008

8) Notified body: ICIM S.p.A. N.B. no. 0425 have issued the certificate of conformity for the factory production control no. 0425 CPD 1228.

9) Declared performances:

Essential characteristics	Performance-grade	Paragraph
Category of use	3 - high frequency	7.1
Durability	7 - 200.000 cycles	7.2
Door mass	7 - over 200kg	7.3
Suitability for use on fire/smoke doors	B - suitable	7.4
Safety toward people	1 - for escape routes	7.5
Corrosion resistance	3 - 96 h (high resist.)	7.6
Security toward goods	2 - 1000N	7.7
Projection of horizontal bar	1 - up to 150mm	7.8
Type of horizontal bar operation	A - push-bar	7.9
Field of door application	A - 1 or 2 leaved door	7.10
Dangerous substances	conform	ZA

10) Panic bars listed in point 1 and 2 are conform to the performances declared in point 9. This declaration of performance is issued under the exclusive responsibility of the manufacturer listed in point 4.

Signed in the name and on behalf of the manufacturer:



Ninz Karl
legal representative of the NINZ S.p.A.

INSTALLATION, USE AND MAINTENANCE HANDBOOK

A111-GB
5001208/2 - 07/15

SYMBOLS EMPLOYED



CAUTION

Indicates a danger that threatens people and/or material goods. Failure to observe the warnings indicated by this symbol may have serious consequences, such as personal injury and property damage.



ATTENTION

Indicates a danger that threatens material goods. Failure to observe the warnings indicated by this symbol may result in damage to material goods.



NOTICE

Warnings related to important technical aspects.

PRODUCT DESCRIPTION

Panic bar for one-leaved doors or for the active leaf of two-leaved doors located at emergency exits and activated by push-bars. Composed of galvanized steel controls, black plastic casing and lever, horizontal aluminium bar, external plate, panic safe lock and nickel-plated brass cylinder with three keys.

OPERATION MODE

From the pull side (external plate side), the door can only be opened by key, which retracts the latch bolt, whereas opening is possible from the push side at any time by pushing on the horizontal bar of the TWIST BS panic bar.

WARNINGS

The TWIST panic bar activated by means of a horizontal bar is intended for use onto doors installed in escape routes where panic situations could develop. The safety features of this product are of fundamental importance to ensure its conformity with EN 1125. It is strictly forbidden to introduce any type of modifications apart from those described in these installation instructions.

RECOMMENDATIONS

In order to ensure that the panic bar could provide a high level of safety toward people and appropriate safety level toward goods, it should only be mounted onto doors and doorframes that are in good conditions. The door itself, therefore, should be checked to ensure that it was installed properly and that nothing obstructs its normal movement.

If rebate sealing are mounted on the door, make sure they do not inhibit proper functioning of the panic bar.



In case of two-leaved door where both leaves are equipped with panic bar, it is mandatory to check that each leaf opens when its respective panic bar is activated, and that leaves open freely when the bars are activated simultaneously.

The fastening instructions in the present document should be followed scrupulously during installation. Once installation is complete, the installer should give this document to the owner of the activity.

The horizontal bar should be installed in a way that maximizes its useable length.

For securing the door in the closed position, do not employ any other latching devices than those specified in the present document. This does not preclude the installation of automatic closing devices.

Different external access devices than those found on the list of certified components on pages 4/4 are considered unacceptable.

The TWIST panic bar is also designed for installation on hollow metal doors with an internal cell structure.

If a door closer is needed to return the door to the closed position, care should be taken not to make the opening step more difficult for children, the elderly and the disabled.

A pictogram (arrow) should be positioned immediately above the horizontal bar on the internal side of the door.



All of the included components described herein must be positioned and mounted in conformity with the present document.

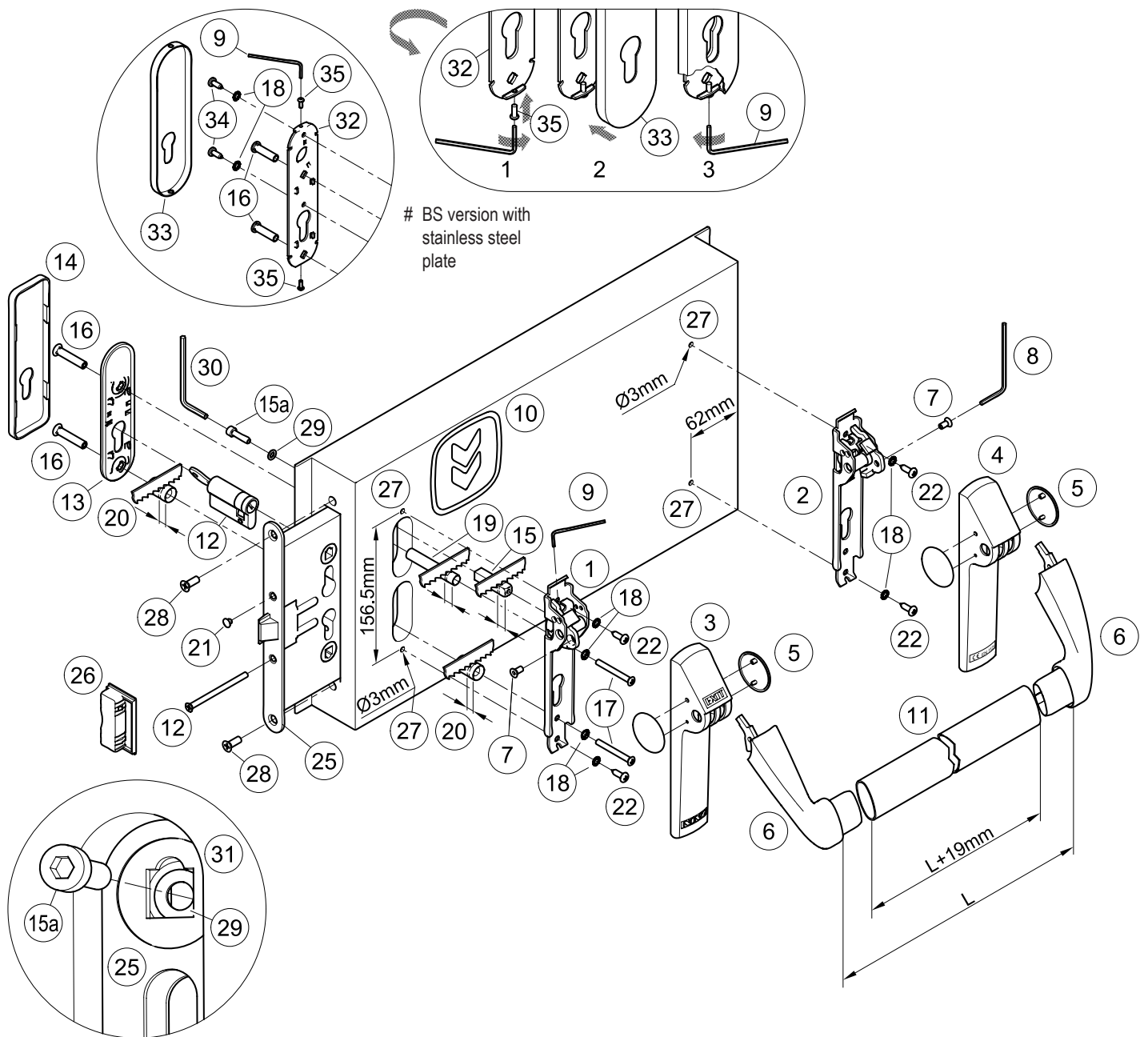

CONTENTS OF THE TWIST BS PANIC BAR KIT PACKAGE

position	pcs.	description	position	pcs.	description
1, 2	01	Twist/Exus mechanism assembly	18	06	Toothed washer (# 8 pcs. for stainless steel version)
3, 4, 5	01	Twist/Exus LP carter set with plugs	19	01	Ø10,3x60,6mm spacer
6	01	Twist set carrier arms	20	02	Ø15,0x23,5mm spacer
7	02	M5x10mm hex socket countersunk screw	21	01	Black cap hole Ø8,8mm
8	01	S3 hex key	22	04	Pan head self tapping screw Ø4,8x16mm
9	01	S2 hex key	25	01	Panic safe lock
10	01	Adhesive pictogram (green arrow)	26	01	Proget strike box lock
11	01	Horizontal bar in anodized aluminium	29	01	Washer
12	01	Standard nickel-plated half cylinder with three keys and fastening screw	30	01	S4 hex key
13	01	Installation plate in galvanized steel	# 32	01	Installation plate in galvanized steel
14	01	Black plastic cover plate	# 33	01	Stainless steel cover plate
15, 15a	01	9x9x40mm threaded square spindle with M5x20mm hex socket screw	# 34	02	Pan head self tapping screw Ø4,2x13mm
16	02	M5 threaded insert	# 35	02	M3x8mm pan head screw
17	02	M5x45mm or M5x50mm countersunk head screw	-	01	A034 hole-drilling template
			-	01	Twist BS Kit panic bar set installation instruction

 Please note that article 4 of the MD of 03 November 2004 obliges the installer to write up, sign and provide the owner of the activity with a declaration of proper installation that makes explicit reference to the instructions supplied by the exit device manufacturer.

TOOLS REQUIRED



Medium-sized Philips-head screwdriver or electric screwdriver, electric drill with Ø2 and Ø3mm drill bit for steel, fine-toothed hack-saw and hack-saw for aluminium.

IMPORTANT

- Installation should be carried out by qualified personnel only and in strict conformity with the instructions supplied.
- For a correct installation all supplied components must be used, including spacers and toothed washers.
-  - No variations are allowed, and only components indicated in the package contents may be used.
- Given its purpose, the Twist BS panic bar should be mounted on the push-side of the door.
- Before proceeding with installation, check the package contents to ensure that no pieces are missing.
- Check the type of external plate to apply and follow the specific instructions.
- Any different installation configuration from that illustrated on page 2/4 is not allowed.

INSTALLATION



- First disassemble any handles or bar components that are already present.
- Unscrew the two frontal screws (28) and take away the existing lock (25). Install the new panic safe lock (25) and fasten it with the same two frontal screws (28).
- Insert the half cylinder (12) and fasten it temporarily with the screw (12), then remove the key.
- Adjust the plastic spacers (19 and 20) to the thickness of the leaf so that they do not protrude more than 1mm from it.
- Adjust the threaded square spindle (15) to the thickness of the leaf so that it protrudes 11 ± 1 mm from the door surface; be careful to cut the bevelled side.
-  - Insert the washer (29) over the square hole of the panic safe lock (25), from the pull-side of the door, as showed in drawing (31). Insert the M5x20mm screw (15a) over the washer (29) and screw it at the square spindle (15), using the S4 hex wrench (30). Make sure that washer and square spindle are correctly inserted over the square holes before tighten the screw (15a).
- In case of stainless steel BS version screw onto installation plate (32) the screws (35), just enough to insert the cover plate (33).
- Insert the two threaded inserts (16) in the installation plate (13 or 32), making sure that they are well-centred.
- Insert the two spacers (19 and 20) over the threaded inserts (16) and apply the installation plate on the pull-side of the door, being careful to center the inserts over their respective holes.
- Apply the operating mechanism (1) to the lock side (push-side of the door) after inserting the screws (17), toothed washers (18) and spacer (20). Center the square spindle and screws, starting the screws by hand before fastening them with the screwdriver.
- Use the template to drill the holes (27) with the Ø3mm drill bit, checking the level. If holes are already present, drill them again for the internal reinforcement.
- Fasten the mechanism (1) even more securely with the self-tapping screws Ø4,8x16mm (22) and their toothed washers (18).
- Fix the square spindle (15) at the operating mechanism (1), using the S2 hex wrench (9).
- Fasten the mechanism (2) of the panic bar at hinged side, using the self-tapping screws Ø4,8x16mm (22) and their toothed washers (18).
- Put the plastic carter with "EXIT" wording (3) on the operating mechanism (1) and the other one (4) on the hinged side mechanism (2), snapping them on manually.
- In case of plastic BS version clip the cover plate (14) manually onto installation plate (13).
- Apply the carrier arms (6) and fasten them with the dedicated screws (7), tightening them securely with the included S3 wrench (8).
- Make a precise "L" measurement, cut the aluminium bar (11) adding 19mm and remove the burrs from the cut edge. Remove one carrier arm, attach the bar and re-fasten the entire assembly.
- Apply the plugs (5).
- Finish fastening the cylinder (12), insert the little cap hole (21) in the open hole of the panic safe lock (25).



-  - Push the Twist BS panic bar at any point along the horizontal bar, checking to ensure that the latch bolt of the lock opens easily and fully. Use the same method to check the external side, using the key to retract the latch bolt. Test the door in both open and closed positions, and if necessary file down the plastic strike box (26) of one-leaved doors, or the panic safe lock for inactive leaf of two-leaved doors.
- In case of stainless steel BS version it is also necessary to fasten the installation plate (32) using the self-tapping screws Ø4,2x13mm (34) and their toothed washers (18) after drilling holes in the metal panel with the Ø2mm drill bit. Insert the cover plate (33) onto installation plate (drw. 2). Using the S2 hex key (9), unscrew the screws (35) until the cover become fixed, avoiding any deformation (drw. 3).
- Apply the pictogram (10) with the green arrow on the internal surface of the door, just above the horizontal bar.
-  - Lastly, use a dynamometer to measure the force required on the horizontal bar to release the lock. Record this force measurement in the present document.

USE

- Ensure that the door always opens easily.
- Avoid unnecessary strains on or handling onto external plate and exit bar.
- Protect the panic bar from external atmospheric agents.
- Ensure that nothing hinders the free movement of the horizontal bar.
- Do not paint the lock.
- Use the bar properly, do not pull it in the wrong direction.
- Do not leave the key in the lock.
-  - Make sure that any damaged or malfunctioning parts are replaced immediately.

MAINTENANCE

- To ensure that door usage conforms with regulations, the following maintenance checks should be carried out at least once a month:
- Confirm that all of the installed components correspond with those listed in the present instructions and that no other latching devices than those originally installed have been added to the door.
 - Inspect and activate the panic bar to verify that all of its components are in satisfactory operational condition.
 - Use a dynamometer to confirm that the release force shows no significant differences from the forces recorded at the time of installation.
 -  - Check whether all screws are fully tightened, tightening any that may have loosened.
 - Check whether panic bar and key can be moved with minimal effort, and that the latch bolt of the safe lock retreats from the strike box without offering resistance. If the door has become difficult to open due to friction, the resistance can be reduced by filing the strike box down to the appropriate height.
 - Activate the Twist BS panic bar at both ends of the horizontal bar, checking to ensure full retraction of the latch bolt.
 - Ensure that the latch bolt exits completely when the horizontal bar is released.
 - Check the horizontal bar and replace it if any damage or deformities are detected.
 -  - Check whether the inserts and strike boxes are blocked in any way and eliminate any obstructions.
 - This product requires no special maintenance. Grease spray should be used to lubricate the internal workings of the lock and panic bar on a regular basis
 - the latter has a hole on its carter for this purpose, located below the carrier arms.
 - For normal cleaning use mild detergents.

-  - Any adjustments that become necessary must be carried out by qualified personnel using original NINZ replacement parts.
-  - The owner of the activity is responsible for keeping the declaration of correct installation on file, conducting proper panic bar maintenance in accordance with all of the manufacturer's maintenance guidelines, keeping maintenance and check-up records and preserving the present document.

ATTESTATO DI CONFORMITÀ
DIRETTIVA 89/106/CEE
CERTIFICATE OF CONFORMITY
DIRETTIVA 89/106/CEE

Questo certificato è rilasciato in conformità a quanto prescritto dall'Art.6 par.2 lettera b) del DPR 21 aprile 1993, n°246 (Direttiva 89/106/CEE) ed attesta la conformità del prodotto di seguito identificato agli Art.1, Art.2 ed allegato A del DPR 21 aprile 1993, n°246 (Direttiva 89/106/CEE)
This certificate has been issued in conformity to what prescribed by the Art.6 par.2 letter b) of the DPR 21/04/1993, n°246 (Directive 89/106/EEC) and certifies the conformity of the product described below to the Art.1, Art.2 and attachment A of DPR 21/04/1993, n°246 (Directive 89/106/EEC)

ATTESTATO N°	0425 CPD 1228	CERTIFICATE N°	0425
Organismo notificato	ICIM S.p.A. – Piazza Don Mapelli, 75 – 20099 Sesto San Giovanni (MI) ITALY		Notified Body Identification number: 0425
Dati Fabbricante	NINZ S.p.A. Corso Trento, 2/A - 38061 ALA (TN) ITALY		Manufacturer Head office Operative unit
Dati prodotto	DISPOSITIVI ANTIPANICO PER USCITE DI SICUREZZA AZIONATI MEDIANTE UNA BARRA ORIZZONTALE PANIC EXIT DEVICES		
Tipologia			Product Type
Denominazione	Dispositivo antipatico serie "TWIST" "EXUS LP" "EXUS LA" "EXUS LX".		Denomination
Serrature antipatico	art. AP16/18, SCA 1 3201001.019/020, MAC 1 3201001.041/042, 4506002.17 (V), 3201001.018, 485-65-0, 4506002.22 (V), B18310-02-RL-8 (V), B18370-04-LJ-8 (V).		
Controserrature antipatico	art. AP020P, AP020U, 4506002.18 (V), 3201001.6, 43190-95, B1890.1004 (V).		
Dispositivo superiore	art. 3105080, 3105024, 4506003 (V), 3305003, B1795.0001 (V), B1895.0003 (V).		
Riscontro asta	art. 2401036, 2401046, 2401044, 4506005 (V), 2401002, B9000.0567 (V), B9000.0490 (V).		
Boccia pavimento	art. 2401001, 2401007, 3105091, 4509006 (V), 2401020, 4419008, B9028.0001 (V).		
Deviatori	art. 4201010.		
Aste verticali	art. 3305015, 3305016, 3305002, 4509003 (V), 3305013, 990637, B9006.0014 (V), B9006.0008 (V).		
Riscontro serratura	art. 2401006, 2401005, 2401015, 2401014, 4506006 (V), 2401006, 2401035, 3412001, B9000.0402 (V).		
Comandi esterni	art. BM, BSP, BS, BMC, BC, B, A, BM inox, BM alu, BSP inox, BSP alu.		
Sistema di attestazione della conformità	1		Attestation of conformity
Norma di riferimento	EN1125:2008		Standard
Classificazione	3 7 7 B 1 3 2 1 A A		Classification
Eventuali estensioni	Nessuna / None		Extensions
Eventuali condizioni di subordinazione della Certificazione CE	Nessuna / None		Possible conditions of subordination of the CE Certification

Il presente attestato è valido esclusivamente per il prodotto indicato. Eventuali varianti da apportare devono essere approvate da ICIM SpA.
The present issue is valid only for the product described above. Possible changes to have to be approved by ICIM S.p.A.

Data di emissione First issue	Emissione corrente Current issue	Data di scadenza Expiring date
18/04/2007	26/06/2013	17/04/2017

ICIM S.p.A.

SPARE PARTS (see exploded drawing at page 2/4)

position	code	description
1, 2, 3, 4, 5, 6, 7, 8, 10	3102004.001	Twist latch case – black plastic
1, 2	3105113.001	Twist/Exus assembly mechanism
3, 4, 5	3105104.001	Twist/Exus LP carter set with plugs
6	3105122.001	Twist set carrier arm
7, 8	3105026.001	Twist/Exus bag
11	4204009	Anodized or painted aluminium bar set
8, 9, 13, 14, 15, 15a, 16, 17, 18, 19, 20, 21, 22, 29, 30	4211101.003	Twist/Exus BS set - black plastic
# 8, 9, 15, 15a, 16, 17, 18, 19, 20, 21, 22, 29, 30, 32, 33, 34, 35	4211101.023	Twist/Exus BS set - stainless steel
12	4202103.001	Standard nickel-plated half cylinder 40/10 for Proget/Univer thk 60mm
12	4202103.002	35/10 for Univer thickness 50mm
12	4202103.003	30/10 for Rever
25	3201001.016	Panic safe lock to push (AP 16/18)
26	4212024.001	Set of 10 Proget strike box lock
26	4212025.001	Set of 10 Univer thk60 strike box lock
26	4212026.001	Set of 10 Univer thk50 strike box lock
26	4212027.001	Set of 10 Rever strike box lock



FOR REPLACEMENTS USE ORIGINAL NINZ REPLACEMENT PARTS FROM ITS FULL CERTIFIED SYSTEM ONLY!

PROPER DISASSEMBLY

When some parts or all of the panic bar needs to be replaced, the general guideline is to reverse the order of the original installation instructions. To replace the lock, all parts of the panic bar in the locking device zone must be disassembled, including the external plate. The lock itself (25) can be removed by unscrewing the two frontal screws.



This operation should be carried out with great care in order not to damage or move the components located inside lock housing!

MAINTENANCE RECORD			
date	description of the intervention	release force checked	operator

These instructions should be given to the owner of the activity, who must preserve them as a record of the maintenance operations carried out on the panic bar.