

1) Identification code:	<b>TWIST PANIC EXIT DEVICE</b>		9) Declared performances:		
2) Identification number:	4204301.034	KIT TWIST BMC	Essential characteristics	Performance-grade	Paragraph
3) Intended product use:	Panic exit device for escape routes suitable for one-leaved doors or for the active leaf of two-leaved doors with dimensions up to 1350x2880mm/leaf, mass up to 300kg/leaf, mounted on hinges or pivots, with fire resistance up to EI <sub>2</sub> 120 - REI120 and smoke proof. Projection of the bar 100mm.		Category of use	3 - high frequency	7.1
4) Manufacturer:	NINZ S.p.A. - corso Trento 2/A I-38061 ALA (TN) www.ninz.it tel. +39 0464 678300 - fax +39 0464 679025		Durability	7 - 200.000 cycles	7.2
5) Auth. representative:	-		Door mass	7 - over 200kg	7.3
6) Assessment perf. sys.:	system 1		Suitability for use on fire/smoke doors	B - suitable	7.4
7) Harmonized standard:	EN 1125:2008		Safety toward people	1 - for escape routes	7.5
8) Notified body:	ICIM S.p.A. N.B. no. 0425 have issued the certificate of conformity for the factory production control no. 0425 CPD 1228.		Corrosion resistance	3 - 96 h (high resist.)	7.6
			Security toward goods	2 - 1000N	7.7
			Projection of horizontal bar	1 - up to 150mm	7.8
			Type of horizontal bar operation	A - push-bar	7.9
			Field of door application	A - 1 or 2 leaved door	7.10
			Dangerous substances	conform	ZA

10) Panic bars listed in point 1 and 2 are conform to the performances declared in point 9. This declaration of performance is issued under the exclusive responsibility of the manufacturer listed in point 4.



Signed in the name and on behalf of the manufacturer:

  
Ninz Karl  
legal representative of the NINZ S.p.A.

## INSTALLATION, USE AND MAINTENANCE HANDBOOK

**A112-GB**  
5001209/2 - 07/15

### SYMBOLS EMPLOYED

-  **CAUTION**  
Indicates a danger that threatens people and/or material goods. Failure to observe the warnings indicated by this symbol may have serious consequences, such as personal injury and property damage.
-  **ATTENTION**  
Indicates a danger that threatens material goods. Failure to observe the warnings indicated by this symbol may result in damage to material goods.
-  **NOTICE**  
Warnings related to important technical aspects.

### PRODUCT DESCRIPTION

Panic bar for one-leaved doors or for the active leaf of two-leaved doors located at emergency exits and activated by push-bars. Composed of galvanized steel controls, black plastic casing and lever, horizontal aluminium bar, external lever handle and panic safe lock.

### OPERATION MODE

From the pull-side (handle side) the door can be opened at any time whereas from the push-side opening is always possible by using the horizontal bar of the TWIST BMC panic exit device.

### WARNINGS

The TWIST panic bar activated by means of a horizontal bar is intended for use onto doors installed in escape routes where panic situations could develop. The safety features of this product are of fundamental importance to ensure its conformity with EN 1125. It is strictly forbidden to introduce any type of modifications apart from those described in these installation instructions.

### RECOMMENDATIONS

In order to ensure that the panic bar could provide a high level of safety toward people and appropriate safety level toward goods, it should only be mounted onto doors and doorframes that are in good conditions. The door itself, therefore, should be checked to ensure that it was installed properly and that nothing obstructs its normal movement.

If rebate sealing are mounted on the door, make sure they do not inhibit proper functioning of the panic bar.

-  In case of two-leaved door where both leaves are equipped with panic bar, it is mandatory to check that each leaf opens when its respective panic bar is activated, and that leaves open freely when the bars are activated simultaneously.

The fastening instructions in the present document should be followed scrupulously during installation. Once installation is complete, the installer should give this document to the owner of the activity.

The horizontal bar should be installed in a way that maximizes its useable length.

For securing the door in the closed position, do not employ any other latching devices than those specified in the present document. This does not preclude the installation of automatic closing devices.

Different external access devices than those found on the list of certified components on pages 4/4 are considered unacceptable.

The TWIST panic bar is also designed for installation on hollow metal doors with an internal cell structure.

If a door closer is needed to return the door to the closed position, care should be taken not to make the opening step more difficult for children, the elderly and the disabled.

A pictogram (arrow) should be positioned immediately above the horizontal bar on the internal side of the door.

-  All of the included components described herein must be positioned and mounted in conformity with the present document.

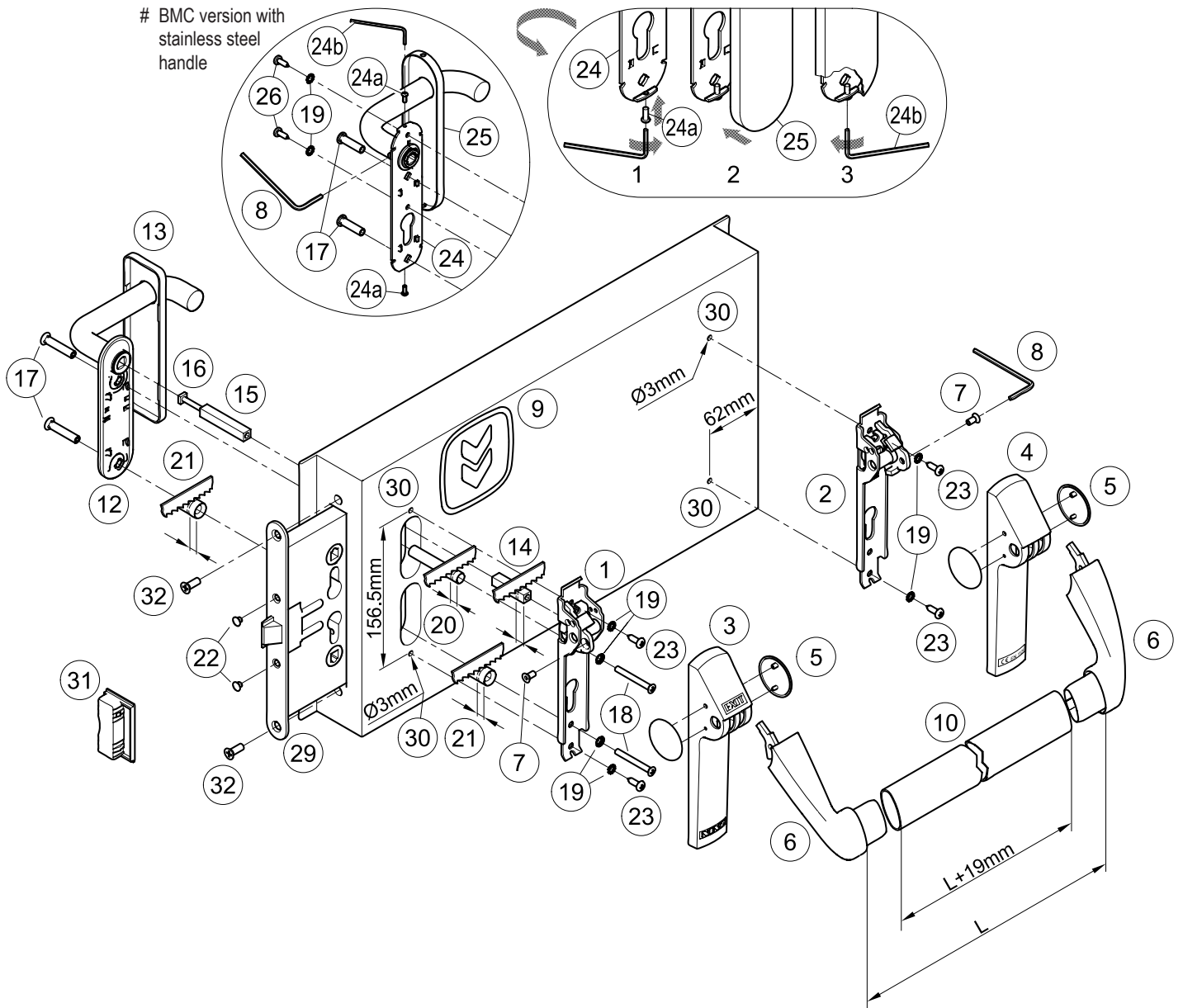

#### CONTENTS OF THE TWIST BMC PANIC BAR KIT PACKAGE

position	pcs.	description	position	pcs.	description
1, 2	01	Twist/Exus mechanism assembly	20	01	Ø10,3x60,6mm spacer
3, 4, 5	01	Twist/Exus LP carter set with plugs	21	02	Ø15,0x23,5mm spacer
6	01	Twist set carrier arms	22	02	Black cap hole Ø8,8mm
7	02	M5x10mm hex socket countersunk screw	23	04	Pan head self tapping screw Ø4,8x16mm
8	01	S3 hex key	24 #	01	Stainless steel handle with galvanized steel installation plate and fastening socket set screw
9	01	Adhesive pictogram (green arrow)	24a #	02	M3x8mm pan head screw
10	01	Horizontal bar in anodized aluminium	24b #	01	S2 hex key
12	01	Handle with galvanized steel installation plate	25 #	01	Blank cover plate in stainless steel
13	01	Blank cover plate in black plastic	26 #	02	Pan head self tapping screw Ø4,2x13mm
14, 15	01	Square spindle 9x9x(55+40)mm	29	01	Panic safe lock
16	01	M5 screw for threaded square spindle	31	01	Proget strike box lock
17	02	M5 threaded insert	-	01	A034 hole-drilling template
18	02	M5x45mm or M5x50mm countersunk head screw	-	01	Twist BMC Kit panic bar set installation instruction
19	06	Toothed washer (# 8 pcs. for stainless steel version)			

 Please note that article 4 of the MD of 03 November 2004 obliges the installer to write up, sign and provide the owner of the activity with a declaration of proper installation that makes explicit reference to the instructions supplied by the exit device manufacturer.

#### TOOLS REQUIRED

Medium-sized Philips-head screwdriver or electric screwdriver, electric drill with Ø2 and Ø3mm drill bit for steel, fine-toothed hack-saw and hack-saw for aluminium.

## IMPORTANT

- Installation should be carried out by qualified personnel only and in strict conformity with the instructions supplied.
- For a correct installation all supplied components must be used, including spacers and toothed washers.

 - No variations are allowed, and only components indicated in the package contents may be used.

- Given its purpose, the Twist BMC panic bar should be mounted on the push-side of the door.
- Before proceeding with installation, check the package contents to ensure that no pieces are missing.
- Check the type of lever handle to apply and follow the specific instructions.
- Any different installation configuration from that illustrated on page 2/4 is not allowed.

## INSTALLATION

- First disassemble any handles or bar components that are already present.
- Unscrew the two frontal screws (32) and take away the existing lock (29). Install the new panic safe lock (29) and fasten it with the same two frontal screws (32).
- Adjust the plastic spacers (20 and 21) to the thickness of the leaf so that they do not protrude more than 1mm from it.
- Adjust the threaded square spindle (14) to the thickness of the leaf so that it protrudes 11±1mm from the door surface; be careful to cut the bevelled side.
- Insert the square spindles (14 and 15) into the lock for connecting them by tightening the respective screw (16).
- In case of stainless steel handle (24) screw onto his installation plate the screws (24a), just enough to insert the cover plate (25).
- Insert the two threaded inserts (17) in the installation plate of handle (12 or 24), making sure that they are well-centred.
- Insert the two spacers (20 and 21) over the threaded inserts (17) and apply the handle on the pull-side of the door, being careful to center the square spindle and the inserts over their respective holes.
- Apply the operating mechanism (1) to the lock side (push-side of the door) after inserting the screws (18), toothed washers (19) and spacer (21). Center the square spindle and screws, starting the screws by hand before fastening them with the screwdriver.
- Use the template to drill the holes (30) with the Ø3mm drill bit, checking the level. If holes are already present, drill them again for the internal reinforcement.
- Fasten the mechanism (1) even more securely with the self-tapping screws Ø4,8x16mm (23) and their toothed washers (19).
- Fasten the mechanism (2) of the panic bar at hinged side, using the self-tapping screws Ø4,8x16mm (23) and their toothed washers (19).
- Put the plastic carter with "EXIT" wording (3) on the operating mechanism (1) and the other one (4) on the hinged side mechanism (2), snapping them on manually.
- In case of plastic handle (12) insert the cover (13) over the handle and clip it manually on the installation plate.
- Apply the carrier arms (6) and fasten them with the dedicated screws (7), tightening them securely with the included S3 wrench (8).
- Make a precise "L" measurement, cut the aluminium bar (10) adding 19mm and remove the burrs from the cut edge. Remove one carrier arm, attach the bar and re-fasten the entire assembly.
- Apply the plugs (5).
- Insert the two caps (22) in the open holes of the panic safe lock (29).

 - Push the Twist BMC panic bar at any point along the horizontal bar, checking to ensure that the latch bolt of the lock opens easily and fully. Use the same method to check the external handle. Test the door in both open and closed positions and if necessary, file down the plastic strike box (31) of one-leaved doors or the panic safe lock for inactive leaf of two-leaved doors.

- In case of stainless steel handle (24) it is also necessary to fasten his installation plate using the Ø4,2x13mm self-tapping screws (26) and their toothed washers (19) after drilling holes in the metal panel with the Ø2mm drill bit. Insert the cover (25) onto the handle (drw. 2). Using the S2 hex key (24b) to unscrew the screws (24a) until the cover become fixed, avoiding any deformations (drw. 3). Insert and fasten the socket set screw well with the S3 hex key (8).

- Apply the pictogram (9) with the green arrow on the internal surface of the door, just above the horizontal bar.

 - Lastly, use a dynamometer to measure the force required on the horizontal bar to release the lock. Record this force measurement in the present document.

## USE

- Ensure that the door always opens easily.
- Avoid unnecessary strains on or handling onto handle and exit bar.
- Protect the panic bar from external atmospheric agents.
- Ensure that nothing hinders the free movement of the horizontal bar.
- Do not paint the lock.
- Use the bar properly, do not pull it in the wrong direction.

 - Make sure that any damaged or malfunctioning parts are replaced immediately.

## MAINTENANCE

To ensure that door usage conforms with regulations, the following maintenance checks should be carried out at least once a month:

- Confirm that all of the installed components correspond with those listed in the present instructions and that no other latching devices than those originally installed have been added to the door.
- Inspect and activate the panic bar to verify that all of its components are in satisfactory operational condition.
- Use a dynamometer to confirm that the release force shows no significant differences from the forces recorded at the time of installation.

 - Check whether all screws are fully tightened, tightening any that may have loosened.

- Check whether panic bar and handle can be moved with minimal effort, and that the latch bolt of the safe lock retreats from the strike box without offering resistance. If the door has become difficult to open due to friction, the resistance can be reduced by filing the strike box down to the appropriate height.

- Activate the Twist BMC panic bar at both ends of the horizontal bar, checking to ensure full retraction of the latch bolt in both cases.

- Ensure that the latch bolt exits completely when the horizontal bar is released.
- Check the horizontal bar and replace it if any damage or deformities are detected.

 - Check whether the inserts and strike boxes are blocked in any way and eliminate any obstructions.

- This product requires no special maintenance. Grease spray should be used to lubricate the internal workings of lock, handle and panic bar on a regular basis – the latter has a hole on its carter for this purpose, located below the carrier arms.

- For normal cleaning use mild detergents.

 - Any adjustments that become necessary must be carried out by qualified personnel using original NINZ replacement parts.

 - The owner of the activity is responsible for keeping the declaration of correct installation on file, conducting proper panic bar maintenance in accordance with all of the manufacturer's maintenance guidelines, keeping maintenance and check-up records and preserving the present document.



**ATTESTATO DI CONFORMITÀ**  
 DIRETTIVA 89/106/CEE  
**CERTIFICATE OF CONFORMITY**  
 DIRECTIVE 89/106/CEE



Questo certificato è rilasciato in conformità a quanto prescritto dall'Art.6 par.2 lettera b) del DPR 21 aprile 1993, n°246 (Direttiva 89/106/CEE) ed attesta la conformità del prodotto di seguito identificato agli Art.1, Art.2 ed allegato A del DPR 21 aprile 1993, n°246 (Direttiva 89/106/CEE).  
 This certificate has been issued in conformity to what prescribed by the Art.6 par.2 letter b) of the DPR 21/04/1993, n°246 (Directive 89/106/CEE) and certifies the conformity of the product described below to the Art.1, Art.2 and attachment A of DPR 21/04/1993, n°246 (Directive 89/106/CEE).

<b>ATTESTATO N°</b>	<b>0425 CPD 1228</b>	<b>CERTIFICATE N°</b>
<b>Organismo notificato</b>	<b>Notified Body</b>	
ICIM S.p.A. – Piazza Don Mapelli, 75 – 20099 Sesto San Giovanni (MI) ITALY	Identification number: 0425	
<b>Dati Fabbricante</b>	<b>Manufacturer</b>	
Sede legale NINZ S.p.A. Corso Trento, 2/A - 38061 ALA (TN) ITALY	Head office	
Unità operativa	Operative unit	
<b>Dati prodotto</b>	<b>Product</b>	
Tipologia	Type	
<b>DISPOSITIVI ANTIPANICO PER USCITE DI SICUREZZA AZIONATI MEDIANTE UNA BARRA ORIZZONTALE</b>		
<b>PANIC EXIT DEVICES</b>		
Denominazione	Dispositivo antipatico serie "TWIST" "EXUS LP" "EXUS LA" "EXUS LX".	Denomination
Serrature antipatico	art. AP16/18, SCA 1 3201001.019/020, MAC 1 3201001.041/042, 4506002.17 (V), 3201001.018, 485-65-0, 4506002.22 (V), B18310-02-RL-8 (V), B18370-04-U-8 (V).	
Controserrature antipatico	art. AP020P, AP020U, 4506002.18 (V), 3201001.6, 43190-95, B1890.1004 (V).	
Dispositivo superiore	art. 3105080, 3105024, 4506003 (V), 3305003, B1795.0001 (V), B1895.0003 (V).	
Riscontro asta	art. 2401036, 2401046, 2401044, 4506005 (V), 2401002, B9000.0567 (V), B9000.0490 (V).	
Boccola pavimento	art. 2401001, 2401007, 3105091, 4509006 (V), 2401020, 4419008, B9028.0001 (V).	
Deviatori	art. 4201010.	
Aste verticali	art. 3305015, 3305016, 3305002, 4509003 (V), 3305013, 990837, B9006.0014 (V), B9006.0006 (V).	
Riscontro serratura	art. 2401006, 2401005, 2401015, 2401014, 4506006 (V), 2401006, 2401035, 3412001, B9000.0402 (V).	
Comandi esterni	art. BM, BSP, BS, BMC, BC, B, A, BM inox, BM alu, BSP inox, BSP alu.	
Sistema di attestazione della conformità	1	
Norma di riferimento	EN1125:2008	
Classificazione	3   7   7   B   1   3   2   1   A   A	
<b>Eventuali estensioni</b>	Nessuna / None	
<b>Eventuali condizioni di subordinazione della Certificazione CE</b>	Nessuna / None	

Il presente attestato è valido esclusivamente per il prodotto indicato. Eventuali varianti da apportare devono essere approvate da ICIM SpA.  
 The present issue is valid only for the product described above. Possible changes in have to be approved by ICIM S.p.A.

Data di emissione First issue	Emissione corrente Current issue	Data di scadenza Expiring date
18/04/2007	26/06/2013	17/04/2017

ICIM S.p.A. 

SPARE PARTS (see exploded drawing at page 2/4)

position	code	description
1, 2, 3, 4, 5, 6, 7, 8, 9	3102004.001	Twist latch case – black plastic
1, 2	3105113.001	Twist/Exus assembly mechanism
3, 4, 5	3105104.001	Twist/Exus LP carter set with plugs
6	3105122.001	Twist set carrier arm
7, 8	3105026.001	Twist/Exus bag
10	4204009	Anodized or painted aluminium bar set
8, 12, 13, 14, 15, 16, 17, 18, 19, 20, 21, 22, 23	4211101.004	Twist/Exus BMC set - black plastic
# 8, 14, 15, 16, 17, 18, 19, 20, 21, 22, 23, 24, 24a, 24b, 25, 26	4211101.024	Twist/Exus BMC set - stainless steel
29	3201001.016	Panic safe lock to push (AP 16/18)
31	4212024.001	Set of 10 Proget strike box lock
31	4212025.001	Set of 10 Univer thk60 strike box lock
31	4212026.001	Set of 10 Univer thk50 strike box lock
31	4212027.001	Set of 10 Rever strike box lock



FOR REPLACEMENTS USE ORIGINAL NINZ REPLACEMENT PARTS FROM ITS FULL CERTIFIED SYSTEM ONLY!

Certified components for TWIST BMC KIT

- Panic exit device: model "TWIST"
- Panic safe lock: item AP 16/18
- Lock strike boxes: items 2401006, 2401005, 2401015, 2401014
- Operating elements: items BMC, BMC inox

PROPER DISASSEMBLY

When some parts or all of the panic bar needs to be replaced, the general guideline is to reverse the order of the original installation instructions. To replace the lock, all parts of the panic bar in the locking device zone must be disassembled, including the external handle. The lock itself (29) can be removed by unscrewing the two frontal screws.



This operation should be carried out with great care in order not to damage or move the components located inside lock housing!

MAINTENANCE RECORD			
date	description of the intervention	release force checked	operator

These instructions should be given to the owner of the activity, who must preserve them as a record of the maintenance operations carried out on the panic bar.