

- 1) Identification code: **SLASH PANIC EXIT DEVICE**
- 2) Identification number: 4204302.013 KIT SLASH A for PROGET doors  
4204302.016 KIT SLASH AR for PROGET doors
- 3) Intended product use: Panic exit device for escape routes suitable for one-leaved doors or for the active leaf of two-leaved doors with dimensions up to 1350x2880mm/leaf, mass up to 300kg/leaf, mounted on hinges or pivots, with fire resistance up to EI<sub>2</sub>120 - REI120 and smoke proof. AR version for width of leaf 350÷500mm. Projection of the bar 75mm.
- 4) Manufacturer: NINZ S.p.A. - corso Trento 2/A  
I-38061 ALA (TN) [www.ninz.it](http://www.ninz.it)  
tel. +39 0464 678300 - fax +39 0464 679025
- 5) Auth. representative: -
- 6) Assessment perf. sys.: system 1
- 7) Harmonized standard: EN 1125:2008
- 8) Notified body: ICIM S.p.A. N.B. nr. 0425 have issued the certificate of conformity for the factory production control nr. 1308-CPD-2007.

- 9) Declared performances:
- | Essential characteristics               | Performance-grade       | Paragraph |
|---|-------------------------|-----------|
| Category of use                         | 3 - high frequency      | 7.1       |
| Durability                              | 7 - 200.000 cycles      | 7.2       |
| Door mass                               | 7 - over 200kg          | 7.3       |
| Suitability for use on fire/smoke doors | B - suitable            | 7.4       |
| Safety toward people                    | 1 - for escape routes   | 7.5       |
| Corrosion resistance                    | 3 - 96 h (high resist.) | 7.6       |
| Security toward goods                   | 2 - 1000N               | 7.7       |
| Projection of horizontal bar            | 2 - up to 100mm         | 7.8       |
| Type of horizontal bar operation        | B - touch-bar           | 7.9       |
| Field of door application               | A - 1 or 2 leaved door  | 7.10      |
| Dangerous substances                    | conform                 | ZA        |
- 10) Panic bars listed in point 1 and 2 are conform to the performances declared in point 9. This declaration of performance is issued under the exclusive responsibility of the manufacturer listed in point 4.

Signed in the name and on behalf of the manufacturer:

Ninz Karl  
legal representative of the NINZ S.p.A.

## INSTALLATION, USE AND MAINTENANCE HANDBOOK

**A115-GB**  
5001212/2 - 02/14

### SYMBOLS EMPLOYED



#### CAUTION

Indicates a danger that threatens people and/or material goods. Failure to observe the warnings indicated by this symbol may have serious consequences, such as personal injury and property damage.



#### ATTENTION

Indicates a danger that threatens material goods. Failure to observe the warnings indicated by this symbol may result in damage to material goods.



#### NOTICE

Warnings related to important technical aspects.

### PRODUCT DESCRIPTION

Panic bar for the inactive leaf of two-leaved doors located at emergency exits and activated by push-bars. Composed of galvanized steel controls, black plastic carter, horizontal aluminium bar and also panic safe lock, vertical rods, upper bolt-device, upper strike box with roller and floor catch.

### OPERATION MODE

The SLASH A or AR panic exit device is always used in combination with another SLASH panic exit device applicated at the active leaf and therefore no external control is expected. From push-side opening is possible at any time by pushing the horizontal bar which draws back the vertical rods and at the same time pushes back the latch bolt of the active leaf, so that both leaves are free.

### WARNINGS

The SLASH panic bar activated by means of a horizontal bar is intended for use onto doors installed in escape routes where panic situations could develop. The safety features of this product are of fundamental importance to ensure its conformity with EN 1125. It is strictly forbidden to introduce any type of modifications apart from those described in these installation instructions.

If the PROGET door is not prepared for the application of the panic exit device or an already mounted panic bar must be replaced because of a failure or because of lack of CE certification, all components must be replaced following the present installation instructions and drawings.

### RECOMMENDATIONS

In order to ensure that the panic bar could provide a high level of safety toward people and appropriate safety level toward goods, it should only be mounted onto doors and doorframes that are in good conditions. The door itself, therefore, should be checked to ensure that it was installed properly and that nothing obstructs its normal movement.

If door rebate sealing have been mounted on the door, make sure they do not inhibit proper functioning of the panic bar.



It is mandatory to check that each leaf opens when its respective panic bar is activated, and that leaves open freely when the bars are activated simultaneously.

The fastening instructions in the present document should be followed scrupulously during installation. Once installation is complete, the installer should give this document to the owner of the activity.

The horizontal bar should be installed in a way that maximizes its useable length. For securing the door in the closed position, do not employ any other latching devices than those specified in the present document. This does not preclude the installation of automatic closing devices.

The SLASH panic bar is also designed for installation on hollow metal doors with an internal cell structure.

If a door closer is needed to return the door to the closed position, care should be taken not to make the opening step more difficult for children, the elderly and the disabled.

A pictogram (arrow) should be positioned immediately above the horizontal bar on the internal side of the door.



All of the included components described herein must be positioned and mounted in conformity with the present document.

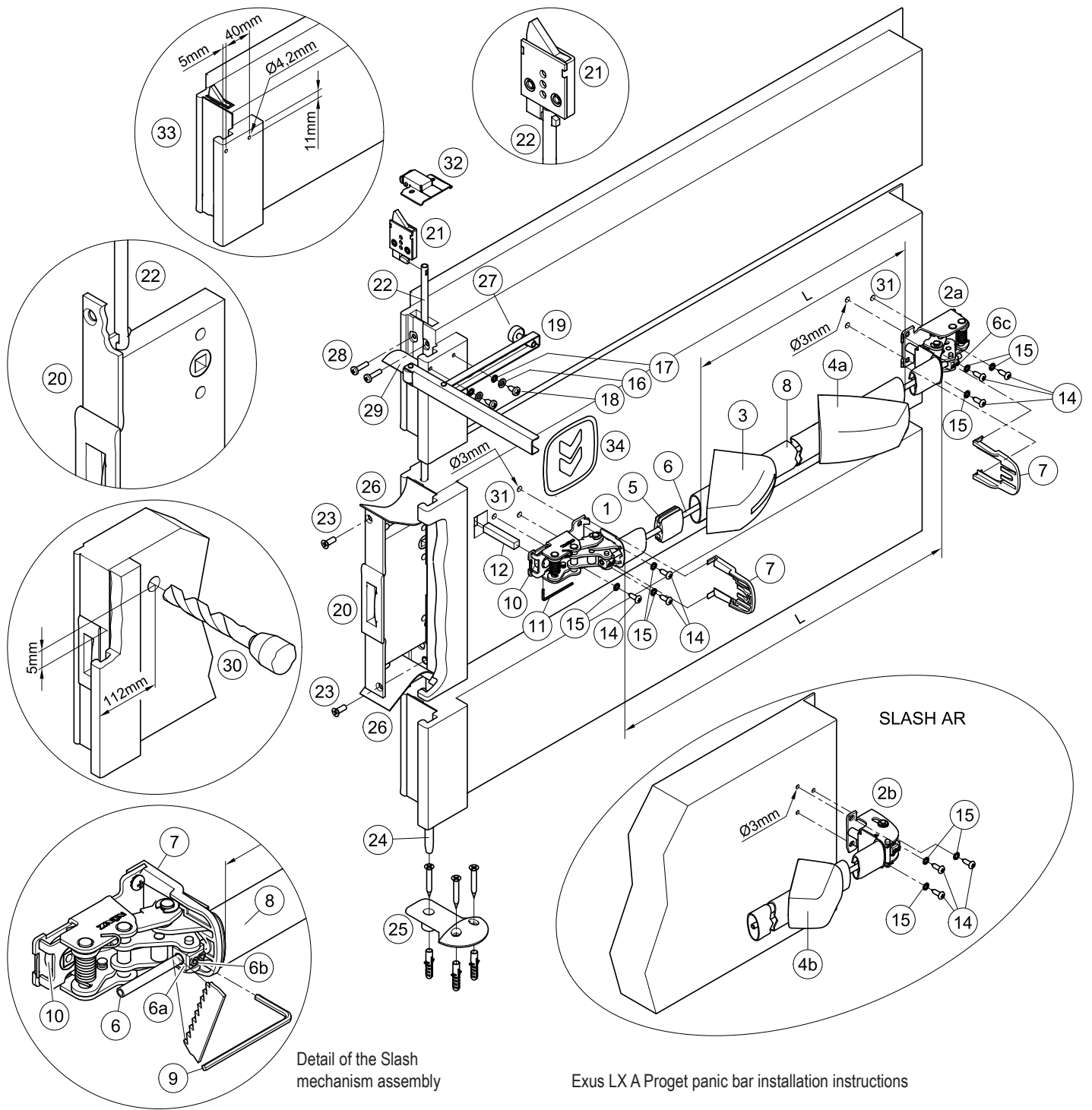

**CONTENTS OF THE SLASH A or AR PANIC BAR PACKAGE**

position	pcs.	description
1, 2a o 2b	01	Slash or Slash AR mechanism assembly
3, 4a o 4b	01	Slash or Slash AR carter set
5	01	Guide for connection pipe
6	01	Connection pipe
7	02	Protection
8	01	Horizontal bar in anodized aluminium
9	01	S3 hex key
11	01	S2 hex key
12	01	Square spindle 9x9x52mm
14	06	Pan head self tapping screw Ø4,8x16mm
15	06	Toothed washer
16	02	Washer

position	pcs.	description
17	02	Toothed washer
18	02	Pan head self tapping screw Ø5,5x13mm
19, 27	01	Carrier arm
20	01	Panic safe lock for passive leaf
21, 28	01	Upper bolt-device with screw
25	01	Proget floor catch with 3 plastic anchors
34	01	Adhesive pictogram (green arrow)
-	01	A034 hole-drilling template
-	01	Slash A or AR Proget panic bar installation instructions

N.B. before mounting the panic exit device the leaf has to be prepared following the installation instructions.

**TOOLS REQUIRED**

Medium-sized Philips-head screwdriver or electric screwdriver, electric drill with Ø3, Ø4,2 and Ø20mm drill bit for steel, hack-saw for aluminium.

 Please note that article 4 of the MD of 03 November 2004 obliges the installer to write up, sign and provide the owner of the activity with a declaration of proper installation that makes explicit reference to the instructions supplied by the exit device manufacturer.

## IMPORTANT

- Installation should be carried out by qualified personnel only and in strict conformity with the instructions supplied.
- For a correct installation all supplied components must be used, including toothed washers.
-  - No variations are allowed, and only components indicated in the package contents may be used.
- Given its purpose, the Slash A panic bar should be mounted on the push-side of the inactive leaf and the active leaf has to be fitted with a Slash panic exit device, too.
- Before proceeding with installation, check the package contents to ensure that no pieces are missing.
- Any different installation configuration from that illustrated on pag. 2/4 is not allowed.

## INSTALLATION

- To make the work easier, it is best (though not required) to lay the passive (secondary) leaf horizontally across two work benches.
- First disassemble any handles or bar components that are already present.
- Remove the existing panic safe lock (20) by unscrewing the two frontal screws (23) after first detaching the thermo-expanding gasket (26) that is glued over them.
- Remove the present upper bolt-device (21) by unscrewing the two frontal screws (28). In case of fire-rated doors detach first the thermo-expanding gasket (29) that is glued over the screws. The upper bolt-device must be unthread from the central joint dragging with it also the upper vertical connecting rod (22).
- Install the new upper bolt-device (21) included in the supplied KIT, bring the rod (22) and the device (21) in the right position and re-fasten all with the two M5x20mm screws (28).

-  - Install the new panic safe lock (20), making sure to center the square hole of both rods. The operation should be carried out with great care, making sure not to ruin or displace any of the components inside the lock housing. Attention: the hole for the square spindle on the lock mechanism should be turned towards the upper part of the door. Reuse the two M6x16mm screws (23) for the fastening of the panic safe lock. Ensure that the two rods are attached and can move freely.

- In case of fire-rated doors re-glue the thermo expanding gasket (26 and 29), if necessary by using a common silicone and refit the leaf correctly on the frame.
- If not already installed, apply the floor catch (25) by attaching it with the appropriate screws and fasteners according to the door installation instructions.
- Continue with installing the panic exit device and if no hole should have been provided for the passage of the square spindle (12), drill the hole in the metal panel at the push-side of the door at the position indicated in figure (30) by using the Ø20mm drill bit.
- Use the template to drill the holes (31) with the Ø3mm drill bit, checking the level. If holes are already present, drill them again for the internal reinforcement.

-  - Insert the square spindle (12) into the cam (10) of the operating mechanism (1) so that it protrudes 38mm, fix it in this position with the S2 hex key (11).

- Approach the operating mechanism (1) of the panic device at the lock-side (push side of the door), with the lift of the cam (10) turned downwards. Centre correctly the square hole of the panic safe lock (20), fasten the mechanism with the Ø4,8x16mm self-tapping screws (14) and their toothed washers (15).
- Fasten the mechanism (2a or 2b) of the panic bar at hinged side, using the self-tapping screws Ø4,8x16mm (14) and their toothed washers (15).
- Make a precise "L" measurement, cut the horizontal aluminium bar (8), and remove the burrs from the cut edge. Insert the guide (5) for the connection pipe in the center of the bar (8).
- Take out the mechanism (2a or 2b) in order to insert the horizontal bar (8) in the operating mechanism (1); then insert also the connection pipe (6) until it passes through the block (6a).
- Insert the plastic carters in the horizontal bar, first the one with the sticker (3), then the other one without (4a or 4b). Join the bar with the hinged side mechanism (2a or 2b) inserting also the connection pipe (6) before re-fastening the mechanism at the door.
- Fasten provisionally the connection pipe (6) so that it not protrudes from the block, by screwing the two socket set screws (6c) of the hinged side mechanism (2a or 2b) with the S3 hex key (9).
- Maintaining pulled the horizontal bar (8) block the connection pipe (6) by screwing lightly the two socket set screws (6b) of the mechanism at lock side (1). Then verify the complete exit of the counter-latchbolt as well as the full retraction of the upper bolt-device (21) and of the lower rod (24) by pushing the end of the bar on hinged side. If so, fasten the four socket set screws (6b and 6c) until they do not protrude anymore from the block (6a). Otherwise loosen the socket set screws and repeat the operation, making sure that the connection pipe is kept under tension. Lastly cut off the protruding piece of the connection pipe.
- Insert the protections (7) in the designated guides of both mechanisms (for AR only at the lock-side).

- Apply the carters (3 and 4a or 4b) on the relative mechanisms while ensuring that the protections (7) remain in their position. Clip on the carters by pushing softly the horizontal bar; first the wide side, then the narrow side.
- If not yet present, drill the two holes (33) with the Ø4,2mm drill bit at a distance of 11mm from the upper edge of the central joint and 40mm apart from each other. The first hole has to be drilled 5 mm away from the lateral edge as shown in drawing.
- Apply the carrier arm (19) as shown in the drawing, fastening it with the two 5,5x13mm self-tapping screws (18) and their washers (16 and 17).
- Adjust the rubber spacer (27) so that it rests correctly on the leaf.
- Adjust the position of the carrier arm so that using the horizontal bar of the passive leaf causes that the active leaf is pushed just enough to ensure the correct closing sequence for the two leaves (active leaf held in waiting position by the closing regulator).

-  - Push the Slash A panic bar at any point along the horizontal bar to check the complete exit of the counter-latchbolt and the full retraction of the upper bolt-device (21) as well as the lower rod (24). Test the door in both open and closed positions. In case of fire-rated doors verify that the self-closing sequence of the two leaves operates properly.

- Apply the pictogram (34) with the green arrow on the internal surface of the door, just above the horizontal bar.

-  - Lastly, use a dynamometer to measure the force required on the horizontal bar of the Slash A panic exit device to free the passive leaf from the latch bolt of the lock, from the upper bolt-device and from the lower rod. Record this force measurement in the present document.

## USE

- Ensure that the leaf always opens easily.
- Avoid unnecessary strains on or handling of the exit bar.
- Protect the panic bar from external atmospheric agents.
- Avoid anything that could hamper the free movement of the bar.
- Do not paint the panic safe lock of the passive leaf, neither the upper bolt-device, neither the tip of the lower rod and its respective guide.
- Use the bar properly, do not pull it in the wrong direction.
-  - Make sure that any damaged or malfunctioning parts are replaced immediately.

## MAINTENANCE

To ensure that door usage conforms with regulations, the following maintenance checks should be carried out at least once a month:

- Confirm that all of the installed components correspond with those listed in the present instructions and that no other latching devices than those originally installed have been added to the door.
- Inspect and activate the panic bar to verify that all of its components are in satisfactory operational condition.
- Use a dynamometer to confirm that the release force shows no significant differences from the forces recorded at the time of installation.
-  - Check whether all screws are fully tightened, tightening any that may have loosened.

- Push the panic bar at any point along the horizontal bar to check the complete exit of the counter-latchbolt and the full retraction of the upper bolt-device (21) as well as the lower rod (24). Test the door in both open and closed positions.
- Once released the horizontal bar and closed the leaf, verify that the counter-latchbolt retracts fully as well as the upper bolt-device and lower rod exit completely.
- In case of fire-rated doors open the two leaves by acting on the exit bar of the secondary leaf and verify the correct closing sequence of the two doors.
- Check the horizontal bar and replace it if any damage or deformities are detected.
-  - Ensure that the upper strike box with roller and floor catch are not blocked; if so, remove the obstruction.
- The product requires no special maintenance. Grease spray should be used to lubricate the upper bolt-device, the lower rod guide, internal workings of the lock and panic bar on a regular basis – the latter has a hole on its carter for this purpose.
- For normal cleaning use mild detergents.

-  - Any adjustments that become necessary must be carried out by qualified personnel using original NINZ replacement parts.

-  - The owner of the activity is responsible for keeping the declaration of correct installation on file, conducting proper exit bar maintenance in accordance with all of the manufacturer's maintenance guidelines, keeping maintenance and check-up records and preserving the present document.

