



NINZ S.p.A. - corso Trento, 2/A
I-38061 ALA (TN) / ITALY www.ninz.it
Tel. + 39 0 464 678300
Fax. +39 0 464 679025 info@ninz.it

EXUS LX BC
PANIC EXIT DEVICE
for emergency exits

A226-GB

5001323/2 - 07/15

Denomination **EXUS LX PANIC EXIT DEVICE**

Commercial codes
EXUS LX BC

item 4201101.149

Name and address of the producer
NINZ S.p.A. - corso Trento 2/A
I-38061 ALA (TN) - ITALY

Classification no.

- 1st Character - grade 3 - Category of use: high frequency
- 2nd Character - grade 7 - Durability: 200.000 cycles
- 3rd Character - grade 7 - Mass of the door: over 200kg
- 4th Character - grade B - Suitable for use on fire/smoke rated doors
- 5th Character - grade 1 - Safety: suitable for emergency exits
- 6th Character - grade 3 - Highly resistant to corrosion 96h
- 7th Character - grade 2 - Safety of goods: 1000N
- 8th Character - grade 1 - Protrusion of the exit bar: up to 150mm
- 9th Character - grade A - Activation type: push bar
- 10th Character - grade A - Suitable for 1 or 2 leaved door

Year application trademark
2007



Standard EN 1125:2008

Certification authority no.
0425

CE certification no. 0425 CPD 1228

Suitable for doors with one leaf or for the active (first opening) leaf of two-leaved doors up to 1350x2880mm/leaf in size, a mass of up to 300kg/leaf, mounted on hinges or pivots, fire resistant up to EI₂120 - REI120 and smoke proof. Protrusion of the exit bar: 125mm.

Classification 3 7 7 B 1 3 2 1 A A

SYMBOLS EMPLOYED



CAUTION

Indicates a danger that threatens people and/or material goods. Failure to observe the warnings indicated by this symbol may have serious consequences, such as personal injury and property damage.



ATTENTION

Indicates a danger that threatens material goods. Failure to observe the warnings indicated by this symbol may result in damage to material goods.



NOTICE

Warnings related to important technical aspects.

RECOMMENDATIONS

In order to ensure that the panic bar could provide a high level of safety toward people and appropriate safety level toward goods, it should only be mounted onto doors and doorframes that are in good conditions. The door itself, therefore, should be checked to ensure that it was installed properly and that nothing obstructs its normal movement.

If rebate sealing are mounted on the door, make sure they do not inhibit proper functioning of the panic bar.



In case of two-leaved door where both leaves are equipped with panic bar, it is mandatory to check that each leaf opens when its respective panic bar is activated, and that leaves open freely when the bars are activated simultaneously.

PRODUCT DESCRIPTION

Panic bar for one-leaved doors or for the active leaf of two-leaved doors located at emergency exits and activated by push-bars. Composed of stainless steel controls, casing, lever and horizontal bar. Blank stainless steel external plate with galvanized steel installation plate.

This product does not contain or release any hazardous materials, as per UNI EN standard no. 1125 appendix ZA.

The fastening instructions in the present document should be followed scrupulously during installation. Once installation is complete, the installer should give this document to the owner of the activity.

The horizontal bar should be installed in a way that maximizes its useable length.

For securing the door in the closed position, do not employ any other latching devices than those specified in the present document. This does not preclude the installation of automatic closing devices.

OPERATION MODE

From the pull side (blank external plate side) the door can not be opened, whereas opening is possible from the push side at any time by pushing on the horizontal bar of the EXUS LX BC panic bar.

Different external access devices than those found on the list of certified components on pages 4/4 are considered unacceptable.

The EXUS panic bar is also designed for installation on hollow metal doors with an internal cell structure.

WARNINGS

The EXUS panic bar activated by means of a horizontal bar is intended for use onto doors installed in escape routes where panic situations could develop.

The safety features of this product are of fundamental importance to ensure its conformity with EN 1125. It is strictly forbidden to introduce any type of modifications apart from those described in these installation instructions.

If a door closer is needed to return the door to the closed position, care should be taken not to make the opening step more difficult for children, the elderly and the disabled.

A pictogram (arrow) should be positioned immediately above the horizontal bar on the internal side of the door.



All of the included components described herein must be positioned and mounted in conformity with the present document.

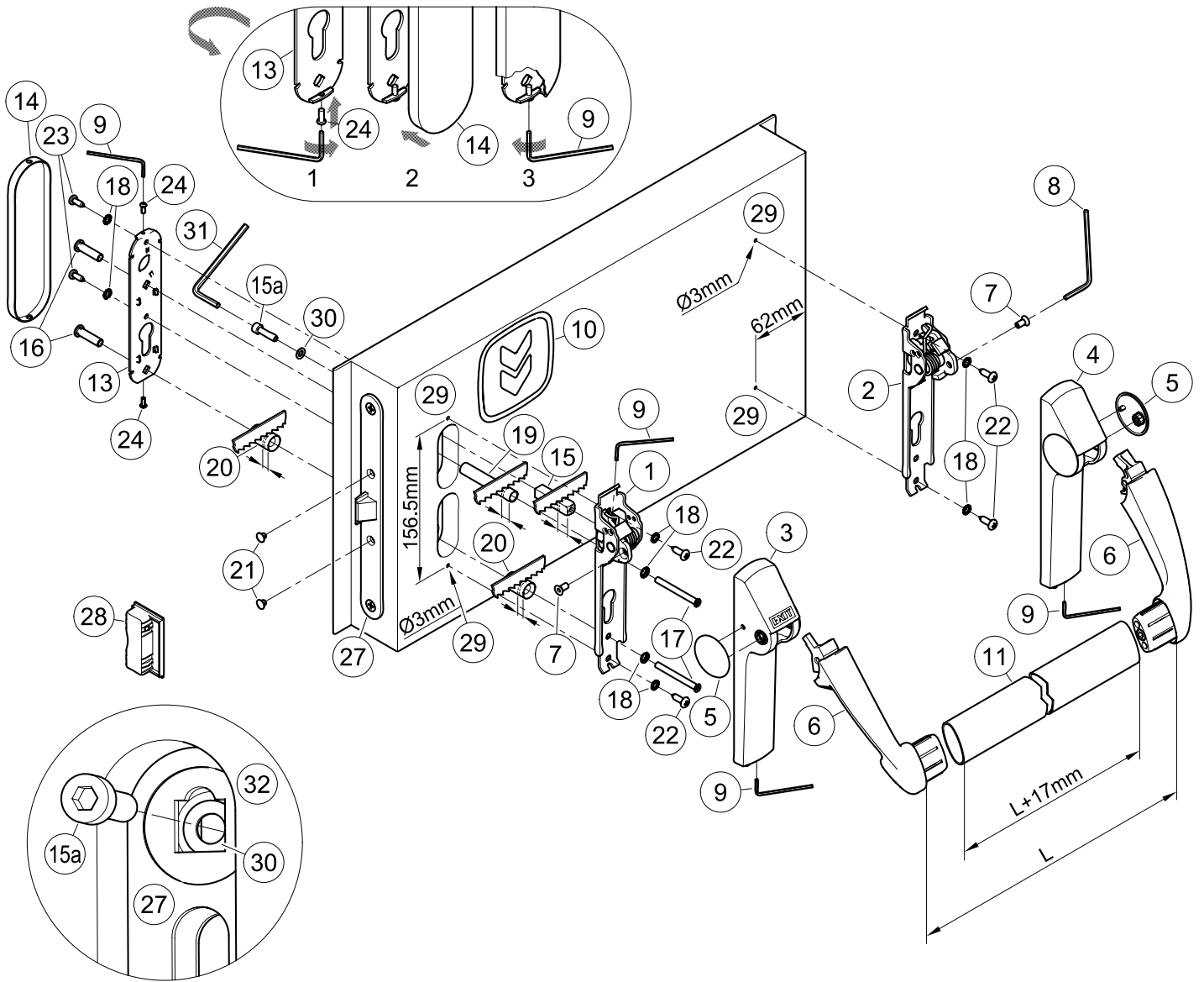

CONTENTS OF THE EXUS LX BC PANIC BAR PACKAGE

position	pcs.	description
1, 2	01	Exus LX mechanism assembly in stainless steel
3, 4, 5	01	Exus LX carter set with plugs
6	01	Exus LX set carrier arms
7	02	M5x10mm hex socket countersunk screw
8	01	S3 hex key
9	01	S2 hex key
10	01	Adhesive pictogram (green arrow)
11	01	Horizontal bar in stainless steel
13	01	Installation plate in galvanized steel
14	01	Blank cover plate in stainless steel
15, 15a	01	9x9x40mm threaded square spindle with M5x20mm hex socket screw
16	02	M5 threaded insert
17	02	M5x50mm countersunk head screw

position	pcs.	description
18	08	Toothed washer
19	01	Ø10,3x60,6mm spacer
20	02	Ø15,0x23,5mm spacer
21	02	Black cap hole Ø8,8mm
22	04	Pan head self tapping screw Ø4,8x16mm
23	02	Pan head self tapping screw Ø4,2x13mm
24	02	M3x8mm pan head screw
30	01	Washer
31	01	S4 hex key
-	01	A034 hole-drilling template
-	01	Exus LX BMC panic bar set installation instruction

- The panic lock (27) and the respective strike box (counterstrike) (28) are delivered already mounted on the door!

Please note that article 4 of the MD of 03 November 2004 obliges the installer to write up, sign and provide the owner of the activity with a declaration of proper installation that makes explicit reference to the instructions supplied by the exit device manufacturer.

TOOLS REQUIRED
Medium-sized Philips-head screwdriver or electric screwdriver, electric drill with Ø2 and Ø3mm drill bit for steel, fine-toothed hack-saw and hack-saw for stainless steel.



IMPORTANT

- Installation should be carried out by qualified personnel only and in strict conformity with the instructions supplied.
- For a correct installation all supplied components must be used, including spacers and toothed washers.

-  - No variations are allowed, and only components indicated in the package contents may be used.
- Given its purpose, the Exus LX BC panic bar should be mounted on the push-side of the door.
- Before proceeding with installation, check the package contents to ensure that no pieces are missing.
- Check if the door is equipped with the panic safe lock.
- Check the type of external plate to apply and follow the specific instructions.
- Any different installation configuration from that illustrated on page 2/4 is not allowed.

INSTALLATION

- Adjust the plastic spacers (19 and 20) to the thickness of the leaf so that they do not protrude from it.
- Adjust the threaded square spindle (15) to the thickness of the leaf so that it protrudes 11 ± 1 mm from the door surface; be careful to cut the bevelled side.
-  - Insert the washer (30) over the square hole of the panic safe lock (27), from the pull-side of the door, as showed in drawing (32). Insert the M5x20mm screw (15a) over the washer (30) and screw it at the square spindle (15), using the S4 hex wrench (31). Make sure that washer and square spindle are correctly inserted over the square holes before tighten the screw (15a).
- Screw onto installation plate (13) the screws (24) just enough to insert the cover plate (14).
- Insert the two threaded inserts (16) in the installation plate (13), making sure that they are well-centred.
- Insert the two spacers (19 and 20) over the threaded inserts (16) and apply the installation plate on the pull-side of the door, being careful to center the inserts over their respective holes.
- Apply the operating mechanism (1) to the lock side (push-side of the door) after inserting the screws (17), toothed washers (18) and spacer (20). Center the square spindle and screws, starting the screws by hand before fastening them with the screwdriver.
- Use the template to drill the holes (29) with the Ø3mm drill bit, checking the level. If holes are already present, drill them again for the internal reinforcement.
- Fasten the mechanism (1) even more securely with the self-tapping screws Ø4,8x16mm (22) and their toothed washers (18).
- Fix the square spindle (15) at the operating mechanism (1), using the S2 hex wrench (9).
- Fasten the mechanism (2) of the panic bar at hinged side, using the self-tapping screws Ø4,8x16mm (22) and their toothed washers (18).
- Remove the externally-facing plugs (5) from both carter (3 and 4). To do this, insert a finger inside the carter and push the plug out, being careful not to remove the plastic insert. Apply the carter with "EXIT" wording (3) on the operating mechanism (1) and the other one (4) on the mechanism from hinged side (2). Do not fasten the socked set screws, so as to let the two carter movable.
- Apply the carrier arms (6) and fasten them with the dedicated screws (7), tightening them securely with the included S3 wrench (8).
- Make a precise "L" measurement, cut the stainless steel bar (11) adding 17mm, and remove the burrs from the cut edge. Remove one carrier arm, attach the bar and re-fasten the entire assembly.
- Finish fastening of the two carter (3 and 4), screw on without overtighten the socked set screw, using the S2 hex key (9), then apply the plugs (5).
- Insert the two caps (21) in the open holes of the panic safe lock (27).



-  - Push the Exus LX BC panic bar at any point along the horizontal bar, checking to ensure that the latch bolt of the lock opens easily and fully. Test the door in opened and closed position and if necessary file down the plastic strike box (28) of one-leaved doors or the panic safe lock for inactive leaf of two-leaved doors.
- Fasten the installation plate (13) using the self-tapping screws Ø4,2x13mm (23) and their toothed washers (18) after drilling holes in the metal panel with the Ø2mm drill bit. Insert the cover plate (14) onto installation plate (drw. 2). Using the S2 hex key (9), unscrew the screws (24) until the cover become fixed, avoiding any deformation (drw. 3).
- Apply the pictogram (10) with the green arrow on the internal surface of the door, just above the horizontal bar.
-  - Lastly, use a dynamometer to measure the force required on the horizontal bar to release the lock. Record this force measurement in the present document.



USE

- Ensure that the door always opens easily.
- Avoid unnecessary strains on or handling onto external plate and exit bar.
- Protect the panic bar from external atmospheric agents.
- Ensure that nothing hinders the free movement of the horizontal bar.
- Do not paint the lock.
- Use the bar properly, do not pull it in the wrong direction.
-  - Make sure that any damaged or malfunctioning parts are replaced immediately.

MAINTENANCE

To ensure that door usage conforms with regulations, the following maintenance checks should be carried out at least once a month:

- Confirm that all of the installed components correspond with those listed in the present instructions and that no other latching devices than those originally installed have been added to the door.
- Inspect and activate the panic bar to verify that all of its components are in satisfactory operational condition.
- Use a dynamometer to confirm that the release force shows no significant differences from the forces recorded at the time of installation.
-  - Check whether all screws are fully tightened, tightening any that may have loosened.
- Check whether panic bar can be moved with minimal effort, and that the latch bolt of the safe lock retreats from the strike box without offering resistance. If the door has become difficult to open due to friction, the resistance can be reduced by filing the strike box down to the appropriate height.
- Activate the Exus LX BC panic bar at both ends of the horizontal bar, checking to ensure full retraction of the latch bolt in both cases.
- Ensure that the latch bolt exits completely when the horizontal bar is released.
- Check the horizontal bar and replace it if any damage or deformities are detected.
-  - Check whether the inserts and strike boxes are blocked in any way and eliminate any obstructions.
- This product requires no special maintenance. Grease spray should be used to lubricate the internal workings of lock and panic bar on a regular basis – the latter has a hole on its carter for this purpose, located below the carrier arms.
- For normal cleaning, use a cleaning agent designed specifically for stainless steel.

-  - Any adjustments that become necessary must be carried out by qualified personnel using original NINZ replacement parts.
-  - The owner of the activity is responsible for keeping the declaration of correct installation on file, conducting proper panic bar maintenance in accordance with all of the manufacturer's maintenance guidelines, keeping maintenance and check-up records and preserving the present document.

ATTESTATO DI CONFORMITÀ
DIRETTIVA 89/106/CEE
CERTIFICATE OF CONFORMITY
DIRETTIVE 89/106/CEE

ICIM **0425**

Questo certificato è rilasciato in conformità a quanto prescritto dall'Art.6 par.2 lettera b) del DPR 21 aprile 1993, n°246 (Direttiva 89/106/CEE) ed attesta la conformità del prodotto di seguito identificato agli Art.1, Art.2 ed allegato A del DPR 21 aprile 1993, n°246 (Direttiva 89/106/CEE)
This certificate has been issued in conformity to what prescribed by the Art.6 par.2 letter b) of the DPR 21/04/1993, n°246 (Directive 89/106/CEE) and certifies the conformity of the product described below to the Art.1, Art.2 and attachment A of DPR 21/04/1993, n°246 (Directive 89/106/CEE)

ATTESTATO N°	0425 CPD 1228	CERTIFICATE N°
Organismo notificato	Notified Body	
ICIM S.p.A. - Piazza Don Mapelli, 75 - 20099 Sesto San Giovanni (MI) ITALY	Identification number: 0425	
Dati Fabbricante	Manufacturer	
Sede legale NINZ S.p.A. Corso Trento, 2/A - 38061 ALA (TN) ITALY	Head office	
Unità operativa	Operative unit	
Dati prodotto	Product	
Tipologia	Type	
DISPOSITIVI ANTIPANICO PER USCITE DI SICUREZZA AZIONATI MEDIANTE UNA BARRA ORIZZONTALE PANIC EXIT DEVICES		
Denominazione	Denomination	
Dispositivo antipanico	serie "TWIST" "EXUS LP" "EXUS LA" "EXUS LX".	
Serrature antipanico	art. AP16/18, SCA 1 3201001.019/020, MAC 1 3201001.041/042, 4506002.17 (V), 3201001.018, 485-65-0, 4506002.22 (V), B18310-02-RL-8 (V), B18370-04-U-8 (V).	
Controserrature antipanico	art. AP020P, AP020U, 4506002.18 (V), 3201001.6, 43190-95, B1890.1004 (V).	
Dispositivo superiore	art. 3105080, 3105024, 4506003 (V), 3305003, B1795.0001 (V), B1895.0003 (V).	
Riscontro asta	art. 2401036, 2401046, 2401044, 4506005 (V), 2401002, B9000.0567 (V), B9000.0490 (V).	
Boccola pavimento	art. 2401001, 2401007, 3105091, 4509006 (V), 2401020, 4418008, B9028.0001 (V).	
Deviatori	art. 4201010.	
Aste verticali	art. 3305015, 3305016, 3305002, 4509003 (V), 3305013, 990837, B9006.0014 (V), B9006.0006 (V).	
Riscontro serratura	art. 2401006, 2401005, 2401015, 2401014, 4506006 (V), 2401006, 2401035, 3412001, B9000.0402 (V).	
Comandi esterni	art. BM, BSP, BS, BMC, BC, B, A, BM inox, BM alu, BSP inox, BSP alu.	
Sistema di attestazione della conformità	1	
Norma di riferimento	EN1125:2008	
Classificazione	3 7 7 B 1 3 2 1 A A	
Eventuali estensioni	Nessuna / None	
Eventuali condizioni di subordinazione della Certificazione CE	Nessuna / None	
Il presente attestato è valido esclusivamente per il prodotto indicato. Eventuali varianti da apportare devono essere approvate da ICIM SpA. The present issue is valid only for the product described above. Possible changes to have to be approved by ICIM S.p.A.		
Data di emissione First issue	Emissione corrente Current issue	Data di scadenza Expiring date
18/04/2007	26/06/2013	17/04/2017

SPARE PARTS (see exploded drawing at page 2/4)

position	code	description
1, 2, 3, 4, 5, 6, 7, 8, 10	3102061.001	Exus LX latch case – stainless steel
1, 2	3105127.001	Exus LX assembly mechanism – stainless steel
3, 4, 5	3105163.001	Exus LX carter set with plugs
6	3105140.001	Exus LX set carrier arm
7, 8	3105026.001	Twist/Exus bag
11	4204016.001	Stainless steel bar set
8, 9, 13, 14, 15, 15a, 16, 17, 18, 19, 20, 21, 22, 23, 24, 30, 31	4211101.025	Twist/Exus BC set - stainless steel
27	3201001.016	Panic safe lock to push (AP 16/18)
28	4212024.001	Set of 10 Proget strike box lock
28	4212025.001	Set of 10 Univer thk60 strike box lock
28	4212026.001	Set of 10 Univer thk50 strike box lock
28	4212027.001	Set of 10 Rever strike box lock

Certified components for EXUS LX BC

- Panic exit device: model "EXUS LX"
- Panic safe lock: item AP 16/18
- Lock strike boxes: items 2401006, 2401005, 2401015, 2401014
- Operating element: item BC inox

FOR REPLACEMENTS USE ORIGINAL NINZ REPLACEMENT PARTS FROM ITS FULL CERTIFIED SYSTEM ONLY!

PROPER DISASSEMBLY

When some parts or all of the panic bar needs to be replaced, the general guideline is to reverse the order of the original installation instructions. To replace the lock, all parts of the panic bar in the locking device zone must be disassembled, including the external plate. The lock itself (27) can be removed by unscrewing the two frontal screws.

This operation should be carried out with great care in order not to damage or move the components located inside lock housing!

MAINTENANCE RECORD			
date	description of the intervention	release force checked	operator

These instructions should be given to the owner of the activity, who must preserve them as a record of the maintenance operations carried out on the panic bar.