

- 1) Identification code: **SLASH ALU PANIC EXIT DEVICE**
- 2) Identification number: 4204301.059 KIT SLASH ALU BC
- 3) Intended product use: Panic exit device for escape routes suitable for one-leaved doors or for the active leaf of two-leaved doors with dimensions up to 1350x2880mm/leaf, mass up to 300kg/leaf, mounted on hinges or pivots, with fire resistance up to EI₂120 - REI120 and smoke proof. Projection of the bar 75mm.
- 4) Manufacturer: NINZ S.p.A. - corso Trento 2/A
I-38061 ALA (TN) www.ninz.it
tel. +39 0464 678300 - fax +39 0464 679025
- 5) Auth. representative: -
- 6) Assessment perf. sys.: system 1
- 7) Harmonized standard: EN 1125:2008
- 8) Notified body: ICIM S.p.A. N.B. no. 0425 have issued the certificate of conformity for the factory production control no. 1308-CPD-2007.

- 9) Declared performances:
- | Essential characteristics | Performance-grade | Paragraph |
|---|-------------------------|-----------|
| Category of use | 3 - high frequency | 7.1 |
| Durability | 7 - 200.000 cycles | 7.2 |
| Door mass | 7 - over 200kg | 7.3 |
| Suitability for use on fire/smoke doors | B - suitable | 7.4 |
| Safety toward people | 1 - for escape routes | 7.5 |
| Corrosion resistance | 3 - 96 h (high resist.) | 7.6 |
| Security toward goods | 2 - 1000N | 7.7 |
| Projection of horizontal bar | 2 - up to 100mm | 7.8 |
| Type of horizontal bar operation | B - touch-bar | 7.9 |
| Field of door application | A - 1 or 2 leaved door | 7.10 |
| Dangerous substances | conform | ZA |
- 10) Panic bars listed in point 1 and 2 are conform to the performances declared in point 9. This declaration of performance is issued under the exclusive responsibility of the manufacturer listed in point 4.

Signed in the name and on behalf of the manufacturer:





Ninz Karl
legal representative of the NINZ S.p.A.

INSTALLATION, USE AND MAINTENANCE HANDBOOK

A235-GB
5001332/2 - 07/15

SYMBOLS EMPLOYED

-  **CAUTION**
Indicates a danger that threatens people and/or material goods. Failure to observe the warnings indicated by this symbol may have serious consequences, such as personal injury and property damage.
-  **ATTENTION**
Indicates a danger that threatens material goods. Failure to observe the warnings indicated by this symbol may result in damage to material goods.
-  **NOTICE**
Warnings related to important technical aspects.

PRODUCT DESCRIPTION

Panic bar for one-leaved doors or for the active leaf of two-leaved doors located at emergency exits and activated by touch-bar. Composed of galvanized steel controls, chrome-polished aluminium carter, horizontal aluminium bar, blank stainless steel external plate with galvanized steel installation plate and panic safe lock.

OPERATION MODE

From the pull side (blank external plate side) the door can not be opened, whereas opening is possible from the push side at any time by pushing on the horizontal bar of the SLASH ALU BC panic bar.

WARNINGS

The SLASH panic bar activated by means of a horizontal bar is intended for use onto doors installed in escape routes where panic situations could develop. The safety features of this product are of fundamental importance to ensure its conformity with EN 1125. It is strictly forbidden to introduce any type of modifications apart from those described in these installation instructions.

RECOMMENDATIONS

In order to ensure that the panic bar could provide a high level of safety toward people and appropriate safety level toward goods, it should only be mounted onto doors and doorframes that are in good conditions. The door itself, therefore, should be checked to ensure that it was installed properly and that nothing obstructs its normal movement.

If rebate sealing are mounted on the door, make sure they do not inhibit proper functioning of the panic bar.

 In case of two-leaved door where both leaves are equipped with panic bar, it is mandatory to check that each leaf opens when its respective panic bar is activated, and that leaves open freely when the bars are activated simultaneously.

The fastening instructions in the present document should be followed scrupulously during installation. Once installation is complete, the installer should give this document to the owner of the activity.

The horizontal bar should be installed in a way that maximizes its useable length.

For securing the door in the closed position, do not employ any other latching devices than those specified in the present document. This does not preclude the installation of automatic closing devices.

Different external access devices than those found on the list of certified components on pages 4/4 are considered unacceptable.

The SLASH panic bar is also designed for installation on hollow metal doors with an internal cell structure.

If a door closer is needed to return the door to the closed position, care should be taken not to make the opening step more difficult for children, the elderly and the disabled.

A pictogram (arrow) should be positioned immediately above the horizontal bar on the internal side of the door.

 All of the included components described herein must be positioned and mounted in conformity with the present document.

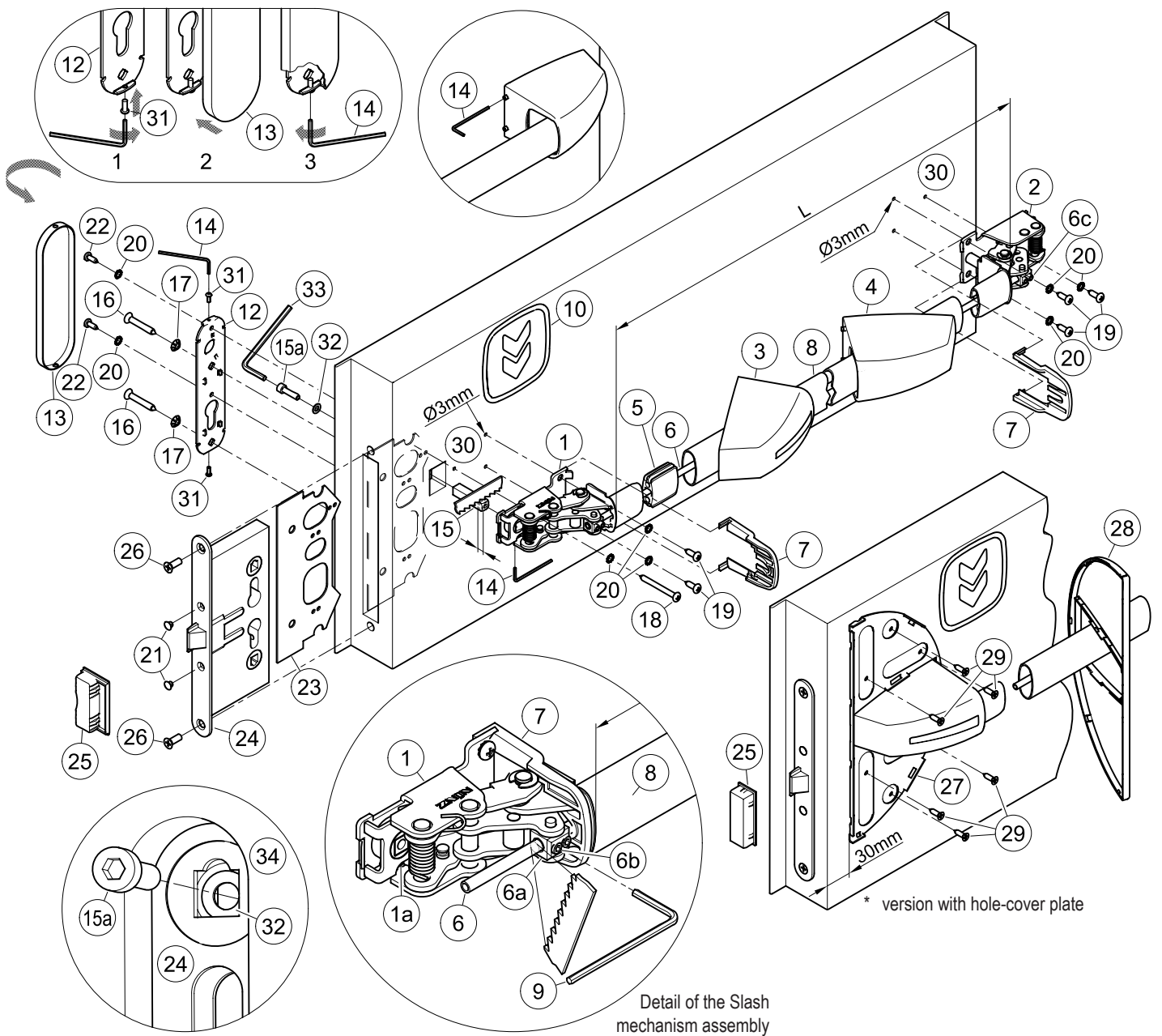

Detail of the Slash mechanism assembly

CONTENTS OF THE SLASH ALU BC PANIC BAR KIT PACKAGE

position	pcs.	description	position	pcs.	description
1, 2	01	Slash mechanism assembly	18	01	Pan head self-tapping screw, Ø4,8x50mm (Proget+Univer) or Ø4,8x38mm (Rever)
3, 4	01	Slash ALU carter set	19	05	Pan head self tapping screw Ø4,8x16mm
5	01	Guide for connection pipe	20	08	M5 toothed washer
6	01	Connection pipe	21	02	Black cap hole Ø8,8mm
7	02	Protection	22	02	Pan head self tapping screw Ø4,2x13mm
8	01	Horizontal bar in anodized aluminium	23	01	Subplate
9	01	S3 hex key	24	01	Panic safe lock
10	01	Adhesive pictogram (green arrow)	25	01	Proget strike box lock
12	01	Installation plate in galvanized steel	* 27	01	Hole-covering base plate
13	01	Blank cover plate in stainless steel	* 28	01	Cover for hole-covering base plate – black
14	01	S2 hex key	* 29	06	Self-drilling countersunk screw Ø4,2x16mm
15, 15a	01	9x9x40mm threaded square spindle with M5x20mm hex socket screw	31	02	M3x8mm pan head screw
16	02	Self-tapping countersunk screw Ø5,5x38mm	32	01	Washer
17	02	M6 toothed washer	33	01	S4 hex key
			-	01	A034 hole-drilling template
			-	01	Slash ALU BC Kit panic bar set installation instruction

 Please note that article 4 of the MD of 03 November 2004 obliges the installer to write up, sign and provide the owner of the activity with a declaration of proper installation that makes explicit reference to the instructions supplied by the exit device manufacturer.

TOOLS REQUIRED

Medium-sized Philips-head screwdriver or electric screwdriver, electric drill with Ø2 and Ø3mm drill bit for steel, fine-toothed and for aluminium hack-saws.

IMPORTANT

- Installation should be carried out by qualified personnel only and in strict conformity with the instructions supplied.
- For a correct installation all supplied components must be used, including toothed washers.



- No variations are allowed, and only components indicated in the package contents may be used.
- Given its purpose, the Slash ALU BC panic bar should be mounted on the push-side of the door.
- Before proceeding with installation, check the package contents to ensure that no pieces are missing.
- Check the type of external plate to apply and follow the specific instructions.
- Any different installation configuration from that illustrated on page 2/4 is not allowed.



INSTALLATION

- First disassemble any handles or bar components that are already present.
- Unscrew the two frontal screws (26) and take away the existing lock (24). Insert the subplate (23) in the hole intended for the lock case. Install the new panic safe lock (24) and fasten it with the same two frontal screws (26).
- For Rever door adjust the threaded square spindle (15) reducing its length for 5mm; be careful to cut the bevelled side.



- Insert the washer (32) over the square hole of the panic safe lock (24), from the pull-side of the door, as showed in drawing (34). Insert the M5x20mm screw (15a) over the washer (32) and screw it at the square spindle (15), using the S4 hex wrench (33). Make sure that washer and square spindle are correctly inserted over the square holes before tighten the screw (15a).
- Screw onto installation plate (12) the screws (31), just enough to insert the cover plate (13).
- Place the installation plate (12) on the pull side of the door and fix it with the screws (16) and their toothed washers (17), centering the respective holes of the installation plate (23).
- Use the template to drill the holes (30) with the Ø3mm drill bit, checking the level. If holes are already present, drill them again for the internal reinforcement.
- Insert the operating mechanism (1) of the panic bar over the square spindle (15), to the lock-side (push-side of the door), with the lift of the cam (1a) turned downwards. Fasten the mechanism starting with the two Ø4,8x16mm screws (19), then with the Ø4,8x50mm (Proget/Univer) or Ø4,8x38mm (Rever) screw (18), with their toothed washers (20).
- Fix the square spindle (15) at the operating mechanism (1), using the S2 hex wrench (14).
- In case of Univer and Rever doors, apply the hole-covering base plate (27) after having provisionally clipped on the carter (3) on the mechanism. Center it vertically above the carter and at a distance of 30mm from the edge of the leaf (see drawing). Fasten the hole-covering base plate provisionally with the two more external screws (29) by first drilling holes in the metal panel with the Ø2mm drill bit, then positioning the cover (28) to verify that it attaches correctly without interfering with the carter. If everything matches, complete fastening with the remaining screws (29) after removing the cover (28) and the carter (3).
- Fasten the mechanism (2) of the panic bar at hinged side, using the self-tapping screws Ø4,8x16mm (19) and their toothed washers (20).
- Make a precise "L" measurement, cut the aluminium bar (8), and remove the burrs from the cut edge. Insert the guide (5) for the connection pipe in the center of the bar.
- Take out the mechanism (2) in order to insert the horizontal bar (8) in the operating mechanism (1); then insert also the connection pipe (6) until it passes through the block (6a).
- Insert the aluminium carters in the horizontal bar, first the one with the sticker (3), then the other one without (4). For Univer or Rever doors insert also the cover (28) between the two carters. Join the bar with the hinged side mechanism (2) inserting also the connection pipe (6) before re-fastening the mechanism at the door.
- Fasten provisionally the connection pipe (6) so that it not protrudes from the block, by screwing the two socket set screws (6c) of the hinged side mechanism (2) with the S3 hex key (9).
- Maintaining pulled the horizontal bar (8) block the connection pipe (6) by screwing lightly the two socket set screws (6b) of the operating mechanism (1). Then verify that the latch bolt retracts completely by pushing the end of the bar from hinged side. In this case screw the four socket set screws (6b and 6c) until they not protrude from the block. Otherwise loosen the socket set screws and repeat the operation, making sure that the connection pipe is

- kept under tension. Lastly cut off the protruding piece of the connection pipe.
- Insert the protections (7) in the designated guides of both mechanisms.
- Apply the carters (3 and 4) on the relative mechanisms while ensuring that the protections (7) remain in their position. Clip on the carters by pushing softly the horizontal bar; first the narrow side, then the wide side. Finally fix the carters fastening their socket set screw without forcing, using the S2 hex key (14).





- Insert the two caps (21) in the open holes of the panic safe lock (24).
-  - Push the Slash ALU BC panic bar at any point along the horizontal bar, checking to ensure that the latch bolt of the lock opens easily and fully. Test the door in opened and closed position and if necessary file down the plastic strike box (25) of one-leaved doors or the panic safe lock for inactive leaf of two-leaved doors.
- Fasten the installation plate (12) using the self-tapping screws Ø4,2x13mm (22) and their toothed washers (20) after drilling holes in the metal panel with the Ø2mm drill bit. Insert the cover plate (13) onto installation plate (drw. 2). Using the S2 hex key (14), unscrew the screws (31) until the cover become fixed, avoiding any deformation (drw. 3).
- If present, the cover (28) has to be clipped on manually at the hole-covering base plate (27).
- Apply the pictogram (10) with the green arrow on the internal surface of the door, just above the horizontal bar.
-  - Lastly, use a dynamometer to measure the force required on the horizontal bar to release the lock. Record this force measurement in the present document.

USE

- Ensure that the door always opens easily.
- Avoid unnecessary strains on or handling onto external plate and exit bar.
- Protect the panic bar from external atmospheric agents.
- Ensure that nothing hinders the free movement of the horizontal bar.
- Do not paint the lock.
- Use the bar properly, do not pull it in the wrong direction.
-  - Make sure that any damaged or malfunctioning parts are replaced immediately.

MAINTENANCE

To ensure that door usage conforms with regulations, the following maintenance checks should be carried out at least once a month:

- Confirm that all of the installed components correspond with those listed in the present instructions and that no other latching devices than those originally installed have been added to the door.
- Inspect and activate the panic bar to verify that all of its components are in satisfactory operational condition.
- Use a dynamometer to confirm that the release force shows no significant differences from the forces recorded at the time of installation.
-  - Check whether all screws are fully tightened, tightening any that may have loosened.
- Check whether panic bar can be moved with minimal effort, and that the latch bolt of the safe lock retreats from the strike box without offering resistance. If the door has become difficult to open due to friction, the resistance can be reduced by filing the strike box down to the appropriate height.
- Activate the Slash ALU BC panic bar at both ends of the horizontal bar, checking to ensure full retraction of the latch bolt in both cases.
- Ensure that the latch bolt exits completely when the horizontal bar is released.
- Check the horizontal bar and replace it if any damage or deformities are detected.
-  - Check whether the inserts and strike boxes are blocked in any way and eliminate any obstructions.
- This product requires no special maintenance. Grease spray should be used to lubricate the internal workings of lock and panic bar on a regular basis – the latter has a hole on its carter for this purpose.
- For normal cleaning use a cleaning agent designed specifically for chrome-polished surfaces for the horizontal bar and another one designed specifically for stainless steel for the external cover plate.
-  - Any adjustments that become necessary must be carried out by qualified personnel using original NINZ replacement parts.
-  - The owner of the activity is responsible for keeping the declaration of correct installation on file, conducting proper panic bar maintenance in accordance with all of the manufacturer's maintenance guidelines, keeping maintenance and check-up records and preserving the present document.

 ATTESTATO DI CONFORMITÀ <small>DIRETTIVA 89/106/CEE</small> CERTIFICATE OF CONFORMITY <small>DIRETTIVA 89/106/CEE</small>				 <small>0425</small>
<small>Questo certificato è rilasciato in conformità a quanto prescritto dall'Art.6 par.2 lettera b) del DPR 21 aprile 1993, n°246 (Direttiva 89/106/CEE) ed attesta la conformità del prodotto di seguito identificato agli Art.1, Art.2 ed allegato A del DPR 21 aprile 1993, n°246 (Direttiva 89/106/CEE) This certificate has been issued in conformity to what prescribed by the Art.6 par.2 letter b) of the DPR 21/04/1993, n°246 (Directive 89/106/EC) and certifies the conformity of the product described below to the Art.1, Art.2 and attachment A of DPR 21/04/1993, n°246 (Directive 89/106/EC)</small>				
ATTESTATO N°		1308 - CPD - 2007		CERTIFICATE N°
Organismo notificato			Notified Body	
ICIM S.p.A. - Piazza Don Mapelli, 75 - 20099 Sesto San Giovanni (MI) ITALY			Identification number: 0425	
Dati fabbricante			Manufacturer	
Sede legale: NINZ S.p.A. Corso Trento, 2/A 38061 ALA (TN) ITALY			Head office	
Unità operativa			Operative unit	
Dati prodotto			Product	
Tipologia	DISPOSITIVI ANTIPANICO PER USCITE DI SICUREZZA AZIONATI MEDIANTE UNA BARRA ORIZZONTALE			Type
Denominazione	PANIC EXIT DEVICES			Denomination
Dispositivo antipanico	Modelli "SLASH", "SLASH AR", "SLASH ALU", "SLASH ALU AR", "SLASH INOX", "SLASH INOX AR". art. AP16/18, SCA 1 3201001.019020, MAC 1 3201001.041042, 3201001.018, 485-65-9.			
Serrature antipanico	art. AP020P, AP020U, 3201001.6, 43190-95.			
Controserrature antipanico				
Dispositivo superiore	art. 3105080, 3105024, 3305003.			
Riscontro asta	art. 2401036, 2401046, 2401044, 2401022.			
Boccola pavimento	art. 2401001, 2401007, 3105091, 2401020, 4419008.			
Deviatori	art. 4201010.			
Aste verticali	art. 3305016, 3305016, 3305002, 3305013, 990837.			
Riscontro serratura	art. 2401006, 2401005, 2401015, 2401014, 2401006, 2401036, 3412001.			
Comandi esterni	art. BM, BSP, BS, BMC, BC, B, A, BM inox, BM alu, BSP inox, BSP alu.			
Sistema di attestazione della conformità	1			Attestation of conformity
Norma di riferimento	EN1125:2008			Standard
Classificazione	3 7 7 B 1 3 2 2 B A			Classification
Eventuali estensioni	Nessuna / None			Extensions
Eventuali condizioni di subordinazione della Certificazione CE	Nessuna / None			Possible conditions of subordination of the CE Certification
<small>Il presente attestato è valido esclusivamente per il prodotto indicato. Eventuali varianti da apportare devono essere approvate da ICIM SpA The present issue is valid only for the product described above. Possible changes to be brought in have to be approved by ICIM SpA.</small>				
Data di emissione	Emissione corrente	Data di scadenza		
First issue	Current issue	Expiring date		
31/05/2007	04/08/2010	30/05/2017		
			 ICIM S.p.A. Il Presidente Ing. Tullio Badino	

SPARE PARTS (see exploded drawing at page 2/4)

position	code	description
1, 2, 3, 4, 5, 7, 10	3102064.001	Slash ALU latch case
1, 2	3105119.001	Slash assembly mechanism
3, 4	3105173.001	Slash ALU carter set
5, 7	3105130.001	Slash 2 protections + 1 plastic piece set
6, 8	4204010	Anodized or painted aluminium bar set
9, 12, 13, 14, 15, 15a, 16, 17, 18, 19, 20, 21, 22, 31, 32, 33	4211102.025	Slash BC set - stainless steel
23	3407013.001	Reinforcement plate
24	3201001.016	Panic safe lock to push (AP 16/18)
25	4212024.001	Set of 10 Proget strike box lock
25	4212025.001	Set of 10 Univer thk60 strike box lock
25	4212026.001	Set of 10 Univer thk50 strike box lock
25	4212027.001	Set of 10 Rever strike box lock
* 27, 28, 29	4204020.002	Slash hole cover + base plate + screws - finishing: black



FOR REPLACEMENTS USE ORIGINAL NINZ REPLACEMENT PARTS FROM ITS FULL CERTIFIED SYSTEM ONLY!

PROPER DISASSEMBLY

When some parts or all of the panic bar needs to be replaced, the general guideline is to reverse the order of the original installation instructions. To replace the lock, all parts of the panic bar in the locking device zone must be disassembled, including the external plate. The lock itself (24) can be removed by unscrewing the two frontal screws.



This operation should be carried out with great care in order not to damage or move the components located inside lock housing!

MAINTENANCE RECORD			
date	description of the intervention	release force checked	operator



These instructions should be given to the owner of the activity, who must preserve them as a record of the maintenance operations carried out on the panic bar.