

# INSTALLATION, APPLICATION AND MAINTENANCE HANDBOOK FOR UNIVER EI<sub>2</sub> 30 AND EI<sub>2</sub> 60 FIRE-RATED SINGLE-LEAF DOORS

**NINZ** S.p.A.  
corso Trento, 2/A  
I-38061 ALA (TN) / ITALY

**170-GB**  
5001507/2  
06/13 1/2

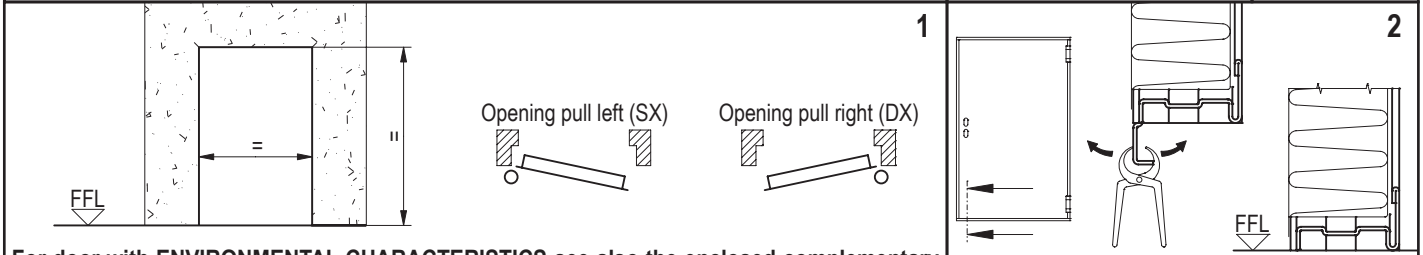

**For door with ENVIRONMENTAL CHARACTERISTICS see also the enclosed complementary installation instructions.**  
Unpack the door and verify the correspondence between the wall opening and the dimension printed on the sticker applied on the frame. Establish the Finished Floor Level (FFL) and the opening direction. Make sure that the walls are made of blocks, bricks or homogeneous cement with a density of  $1200 \pm 400 \text{ kg/m}^3$  and a thickness of min. 150mm.

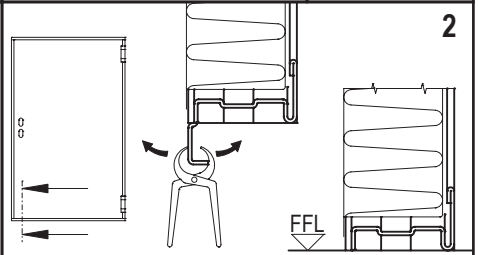

Remove the cover profile from threshold to place the doorset upon the Finished Floor Level (FFL).

## INSTALLATION WITH ANCHORS

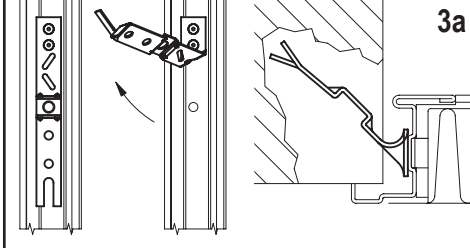

Bend up the frame anchors and mark on the wall their positions respecting the FFL level. Create the holes in the wall for the anchors.

## INSTALLATION WITH EXPANSION SCREWS

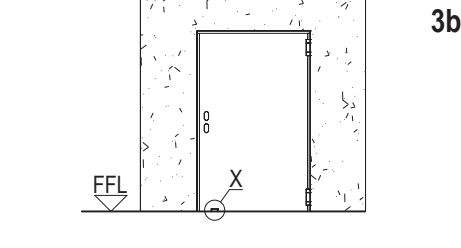

Insert a 10mm spacer under the door leaf with FM  $L \geq 1000 \text{ mm}$  (X). Temporarily immobilise the door in the wall opening, respecting the plumb-line, the FFL level and the parallelism to the wall.

## INSTALLATION WITH PLASTIC ANCHORS

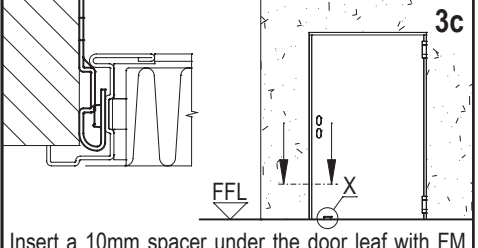

Insert a 10mm spacer under the door leaf with FM  $L \geq 1000 \text{ mm}$  (X). Bend the wall anchors appropriately, temporarily immobilise the door in the wall opening, respecting the plumb-line, the FFL level and the parallelism to the wall.

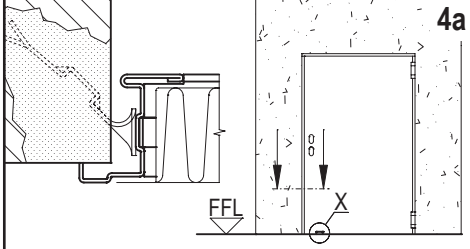

Insert a 10mm spacer under the door leaf with FM  $L \geq 1000 \text{ mm}$  (X). Temporarily immobilise the door in the wall opening, respecting the plumb-line, the FFL level and the parallelism to the wall. Fix the anchors with quick set cement.

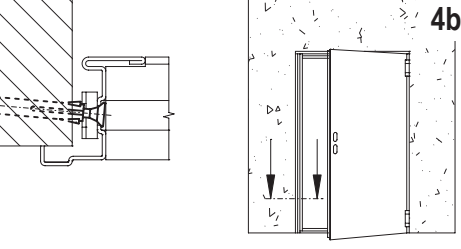

Open the door-leaf and fix the frame at preset holes with expansion screws type Würth art. 0910436112 (expansion screws not supplied), starting with the jamb from hinges side. Close again the door-leaf.

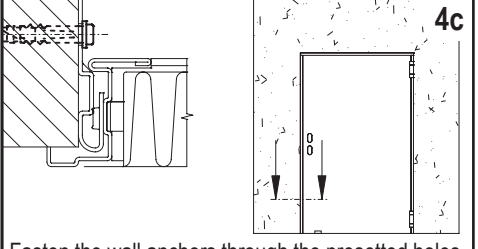

Fasten the wall anchors through the preset holes, using plastic expansion screws Hilti, HRD-UGS  $\varnothing 10 \times 100 \text{ mm}$  and the doorframe in hinges zone, using the Würth art. nr. 0910436112 steel anchor bolts. Expansion screws and anchor bolts are not supplied.

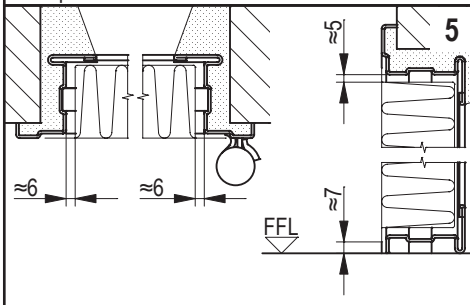

Fill up the space between doorframe and wall with mortar, without bending the frame, cover the frame with plaster and check the leeway.

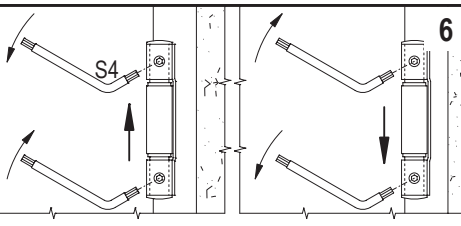

**Ball-bearing hinge**  
To raise the door leaf: unscrew the upper socket set screw, screw on the lower one, screw on the upper one again.  
To lower the door leaf: unscrew the lower socket set screw, screw on the upper one. Operation to be carried out with the maximal care, with the aid of a lever.

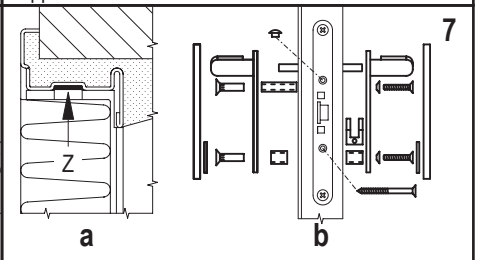

a) Remove spacers between doorframe and leaf, install handle and glue the self expanding gasket (Z) on to the top part of frame.  
b) Install the handle.

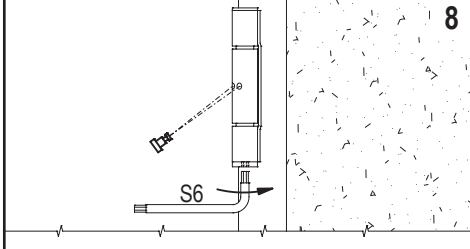

**Spring hinge**  
Wind up the spring hinge in the opening direction, inserting the tension pin. Even if self closing is not needed or door closer is installed, wind up the spring hinge anyway, blocking it with the tension pin.

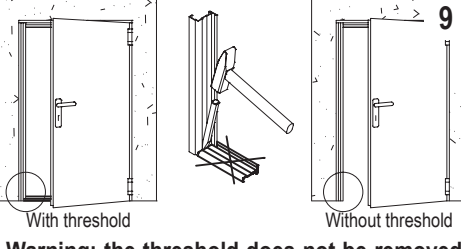

**Warning: the threshold does not be removed in case of door with environmental characteristics.**  
In case the threshold is not needed, cut it with a chisel. Univer door is government approval with or without the bottom frame.

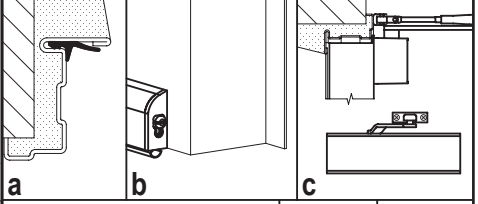

Compulsory accessories for doors:	EI <sub>2</sub> 60 C5	EI <sub>2</sub> 60 Sm
a) FF/CR rebate sealing	-	●
b) automatic door sweep	-	●
c) overhead door closer (anchored in the wall / the spring hinge must be anyhow slightly loaded)	●	-

# INSTALLATION, APPLICATION AND MAINTENANCE HANDBOOK FOR UNIVER EI<sub>2</sub> 30 AND EI<sub>2</sub> 60 FIRE-RATED SINGLE-LEAF DOORS

**NINZ** S.p.A.  
corso Trento, 2/A  
I-38061 ALA (TN) / ITALY

**170-GB**

2/2

## GENERAL NOTES

**STANDARD:** the assemble instructions have to be followed in every detail to respect the test conditions and assure the perfect functioning of the door, including the self-closing. Furthermore a regular service is necessary.

**LIABILITY:** it is duty of the installer to follow the installation instructions in any detail, specifically point 6 and 8, in order to guarantee the safety of the end-users.

**MASONRY WORKS:** it's under customer's responsibility to execute the brickworks according to the norm EN 1634-1, to fill the frames with grout as indicated in box 5 of the present instructions and to keep the wall integral in particular in the anchor points of the door.

**FINISHING:** the serial door is finished with an epoxy-polyester powder paint oven-baked at 180° C. The surface is glossy and particularly resistant.

In case an additional paint is desired we advise to follow these instructions:

- make smooth the surfaces with sandpaper and dust them
- give a first hand of opaque 2 components epoxide using the product ALCEA EPOX 5203 / 0059 (beige)
- finish the surfaces with enamels or paints to your choice.

**CLEANING:** the doors are supplied from the factory clean and packed. We suggest to use a cloth and soaped water only. Do not scratch the surfaces.

**WARRANTY:** the manufacturer gives warranty as per Italian law (C.C.1495). Any claim for missing or damaged goods have to be recorded by inserting a written remark in the delivery notes and must be notified the maximum within eight days from the date of materials receipt.

## CURRENT CE MARKED ACCESSORIES FOR FIRE-RATED DOORS:

Std015 lock:            CE 0497/CPD/4265/11    - EN 12209:2003/AC    - 3 M 3 1 0 C 2 H A 2 0

Hinges:                CE 0789-CPD-2005        - EN 1935:2004        - 4 7 7 1 1 4 0 1 4

## USE AND MAINTENANCE INSTRUCTIONS FOR UNIVER DOORS

All fire-rated doors need regular maintenance in order to verify that no damage occurred and that they close regularly. The scheduled maintenance shall guarantee that the leaf swings correctly and that the self closing mechanism works properly. Doors must be kept free from obstructions.

Any 5.000 opening cycles but at least every 6 months the following operations shall be carried out:

- lubricating the ball-bearing hinge;
- lubricating the spring hinge and the spring after removing the tension pin;
- wind up the spring inserting the tension pin. Verify that the closing force is sufficient to shut the door if opened to 30±2°;
- lubricating the lock and the latch.

Verify the regular functionality of the doors accessories (handle, panic bar, overhead door closer etc.). Their mobile parts shall be lubricated too, following the dedicated instruction.

In case of irregular functioning of the door or its accessories contact an authorized installer or replace the damaged accessories.

Note: for lubrication use viscous products.

## HANDLING AND STORAGE - COMPLAINTS

**Handling:** in case of handling with webbing slings/ropes, place them under the feet of the pallet; avoid to place them under the boards; avoid that the action of slings/ropes produces too much pressure upon the doors, by means of spacers interposed in the upper part. Do not handle the leaves using suction caps.

**Storage:** it is duty of the company/person taking over the doors to store them in a suitable place so that they will be protected from the natural agents and from the direct sun rays. If during transportation or truck unloading it rains or snows on the doors it is necessary to remove immediately the nylon film from each leaf and doorframe put them in vertical position to dry appropriately.

**Complaints:** in case of external visible defects on doors, they have to be marked in the copy of the transportation document to be returned to the forwarder and notified to the manufacturer by registered mail within 48 hours. We remember that according to our general conditions intrinsic defects have to be notified to the manufacturer within 8 days from the delivery date by registered mail. Goods with defects never have to be utilized or assembled, they should be stored at disposal for controls by the manufacturer appointed person.

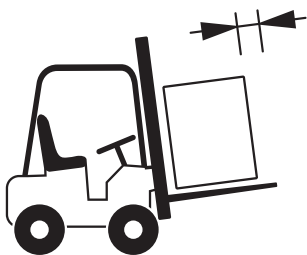

**Move the materials with appropriate means.**

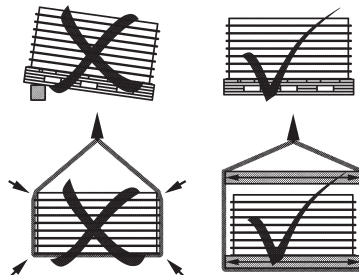

**Store and handle the materials with care.**



**Assemble by qualified staff only.**



**Do not expose the materials to the natural agents.**