

INSTALLATION, USE AND MAINTENANCE HANDBOOK FOR E 60 - EI₂ 90 FIRE-RATED SINGLE-LEAF UNIVER DOORS

NINZ S.p.A.
 corso Trento, 2/A
 I-38061 ALA (TN) / ITALY

I75-GB
 5001512/2
 06/13 1/2

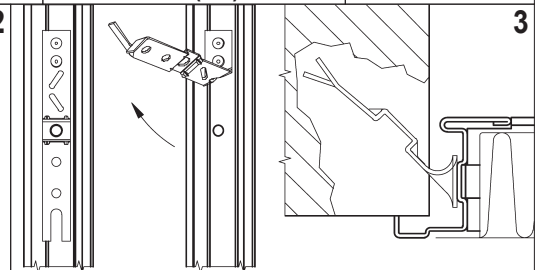
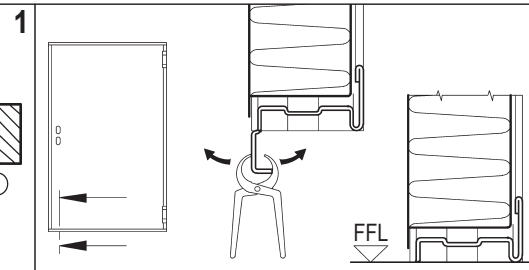
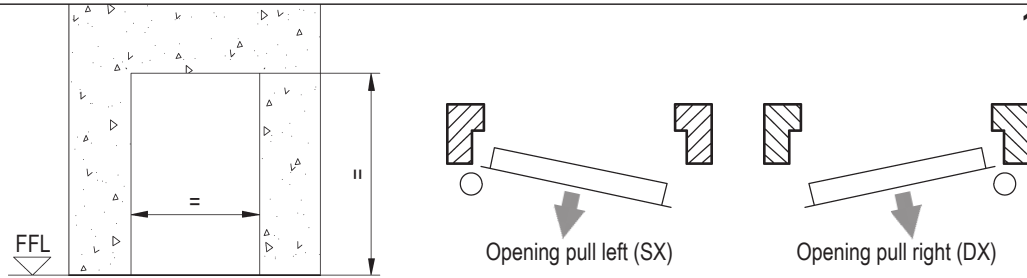

For door with environmental characteristics see also the enclosed complementary installation instructions. Unpack the door being careful do not throw away the FC thermo expanding gasket (included in package) that will be used for the operation in pos. 7. Verify the correspondence between the wall opening and the dimension printed on the sticker applied on the frame. Establish the Finished Floor Level (FFL) and the opening direction. Make sure that the walls are made of blocks, bricks or homogeneous cement with a density of $1200 \pm 400 \text{ kg/m}^3$ and a thickness of min. 150mm.

If the frame rests on the FFL carefully detach internal distance profile.

Bend up the frame-brackets and mark on the wall their positions respecting the FFL. Create the holes in the wall for the brackets.

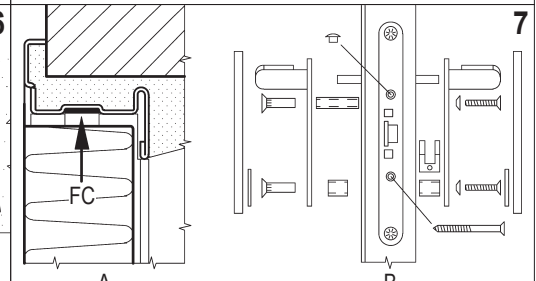
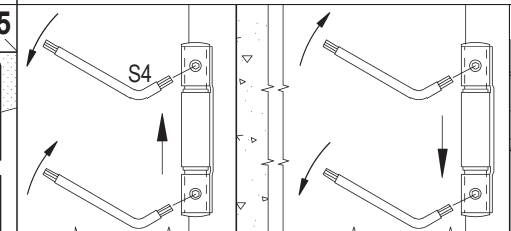
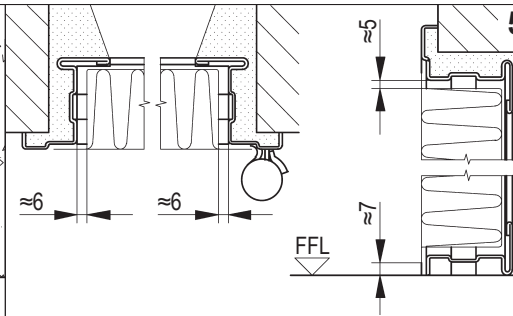
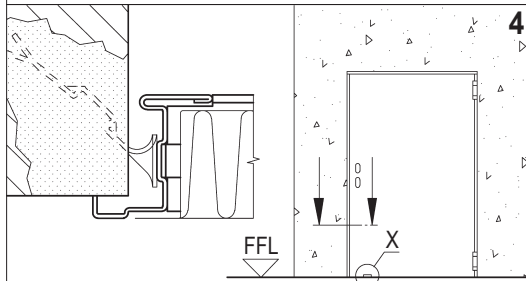

Insert a 10 mm spacer (X) under the door leaf with $FM L \geq 1000 \text{ mm}$. Temporarily immobilize the door in the wall space, using a spirit level, true to the wall, the FFL and the parallel walls and fix the wall anchors with quick drying cement.

Fill up the space between the doorframe and the wall with mortar without bend the doorframe, covering it with plaster and check the leeway.

Remove all the plastic spacers between doorframe and leaf. Adjusting of the bearing hinge: to raise the door leaf unscrew the upper socket set screw, screw on the lower one, screw on the upper one again; to lower the door leaf unscrew the lower socket set screw, screw on the upper one. Operation to be carried out with the max. care with the aid of a lever.

A) Glue the thermo expanding gasket (FC) onto upper transom of doorframe.
 B) Install the door handle.

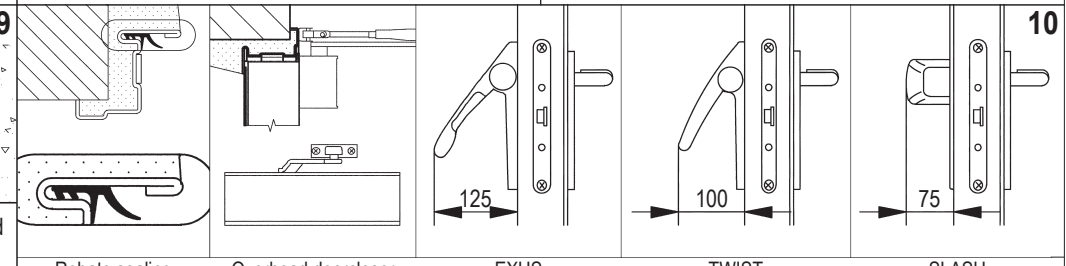
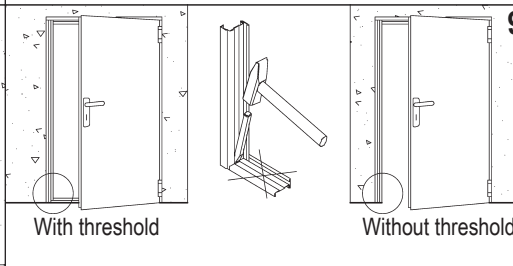
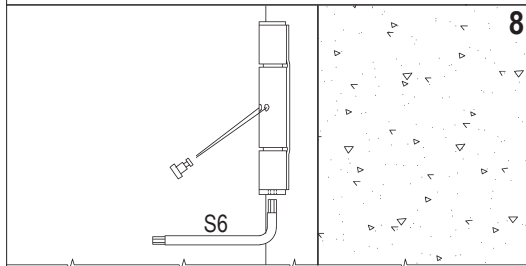

Wind up the spring hinge in the opening direction and insert the tension pin. Even if self closing is not needed or overhead doorclosers are installed, blocking the hinge spring anyway with the tension pin.

Warning: the threshold does not be removed in case of door with environmental characteristics. In case the threshold is not needed, cut it with a chisel. Univer door is government approval with or without the bottom frame.

Accessories: rebate sealing - overhead door closer (the spring hinge must be anyhow slightly loaded) - EXUS, TWIST or SLASH panic bar.

GENERAL NOTES

STANDARD: the assemble instructions have to be followed in every detail to respect the test conditions and assure the perfect functioning of the door, including the self-closing. Furthermore a regular service according to Decree 10th March 1998 is necessary.

LIABILITY: It is duty of the installer to follow the installation instructions in any detail, specifically point 6 and 8 reported at page 1, in order to guarantee the safety of the end-users.

MASONRY WORKS: It's under customer's responsibility to execute the brickworks according to the norm EN 1634-1, to fill the doorframes with concrete as indicated in box 5 on page 1 of the present instructions and to keep the wall integral in particular in the anchor points of the door.

FINISHING: the serial door is finished with an epoxy-polyester powder paint oven-baked at 180 °C. The surface is orange-skin and particularly resistant. In case an additional paint is desired we advise to follow these instructions:
 - make smooth the surfaces with sandpaper and dust them;
 - give a first hand of opaque 2 components epoxide using the product ALCEA EPOX 5203 / 0059 (beige);
 - finish the surfaces with enamels or paints to your choice.

CLEANING: the doors are supplied from the factory clean and packed. We suggest to use a clothe and soaped water only. Do not scratch the surfaces.

WARRANTY: the manufacturer gives warranty as per Italian law (C.C.1495). Any claim for missing or damaged goods have to be recorded by inserting a written remark in the delivery notes and must be notified the maximum within eight days from the date of materials receipt.

CURRENT CE MARKED ACCESSORIES FOR FIRE-RATED DOORS:

Std015 lock: CE 0497/CPD/4265/11 - EN 12209:2003/AC - 3 M 3 1 0 C 2 H A 2 0
 Ball-bearing hinge: CE 0789-CPD-2005 - EN 1935:2004 - 4 7 7 1 1 4 0 14

USE AND MAINTENANCE INSTRUCTIONS FOR UNIVER DOORS

All fire-rated doors or located in escape routes, need regular maintenance in order to verify that no damage occurred and that they close regularly. The scheduled maintenance shall guarantee that the leaf swings correctly and that the self closing mechanism works properly. Doors must be kept free from obstructions.

Any 5.000 opening cycles but at least every 6 months the following operations shall be carried out:

- lubricating the ball-bearing hinge;
- lubricating the spring hinge and the spring after removing the tension pin.
- wind up the spring inserting the tension pin. Verify that the closing force is sufficient to shut the door if opened to 30±2°;
- lubricating the lock and the latch.

Verify the regular functionality of the doors accessories (handle, panic bar, overhead door closer etc.). Their mobile parts shall be lubricated too, following the dedicated instructions.

In case of irregular functioning of the door or its accessories contact an authorized installer or replace the damaged accessories.

N.B.: for lubrication use viscous products.

HANDLING AND STORAGE - COMPLAINTS

Handling: in case of handling with webbing slings/ropes, place them under the feet of the pallet; avoid to place them under the boards; avoid that the action of slings/ropes produces too much pressure upon the doors, by means of spacers interposed in the upper part. Do not handle the leaves using suction caps. **Storage:** it is duty of the company/person taking over the doors to store them in a suitable place so that they will be protected from the natural agents and from the direct sun rays. If during transportation or truck unloading it rains or snows on the doors it is necessary to remove immediately the nylon film from each leaf and doorframe put them in vertical position to dry appropriately. **Complaints:** in case of external visible defects on doors, they have to be marked in the copy of the transportation document to be returned to the forwarder and notified to the manufacturer by registered mail within 48 hours. We remember that according to our general conditions intrinsic defects have to be notified to the manufacturer within 8 days from the delivery date by registered mail. Goods with defects never have be utilized or assembled, they should be stored at disposal for controls by the manufacturer appointed person.

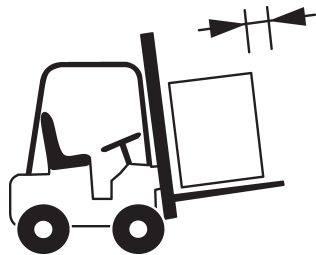

Move the materials with appropriate means.

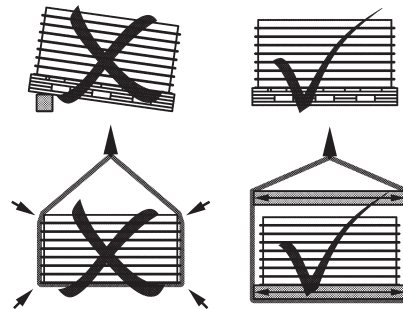

Store and handle the materials with care.

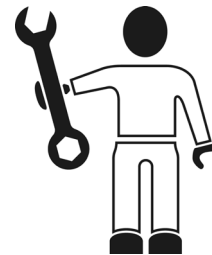

Assemble by qualified staff only.



Do not expose the materials to the natural agents.